

# FOA-INSC09

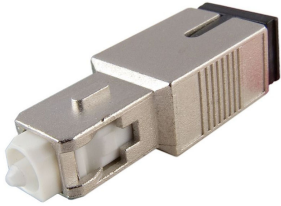

## Fiber Optic Power Reducing Build Out Attenuator, singlemode SC/UPC, 9dB

- Designed to reduce or balance the power in passive optical networks
- Insertable between the connector and the adapter and therefore suited for distribution frames, cabinets and boxes
- High system flexibility because of wave-length independency and polarization insensitivity

## Product Classification

**Regional Availability** Latin America | North America

**Product Type** Fiber attenuator

**Product Series** FOA

## General Specifications

**Interface** SC/UPC

## Outline Drawing

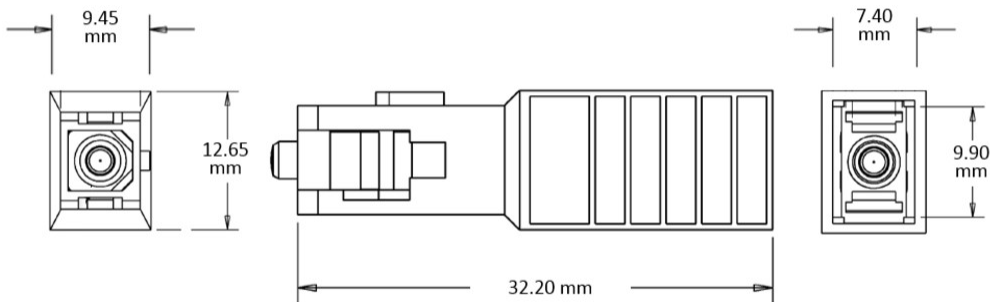

## Optical Specifications

**Fiber Mode** Singlemode

**Fiber Type** G.652.D

**Attenuation, nominal** 9 dB

# FOA-INSC09

---

<b>Operating Wavelength</b>	1430 – 1625 nm
<b>Optical Components Standard</b>	GR-910
<b>Optical Power, maximum</b>	250 mW
<b>Return Loss, minimum</b>	55 dB

## Environmental Specifications

<b>Operating Temperature</b>	-40 °C to +75 °C (-40 °F to +167 °F)
<b>Storage Temperature</b>	-40 °C to +80 °C (-40 °F to +176 °F)

## Regulatory Compliance/Certifications

<b>Agency</b>	<b>Classification</b>
CHINA-ROHS	Above maximum concentration value
REACH-SVHC	Compliant as per SVHC revision on <a href="http://www.commscope.com/ProductCompliance">www.commscope.com/ProductCompliance</a>
ROHS	Compliant/Exempted
UK-ROHS	Compliant/Exempted

