

FOA-INSC03

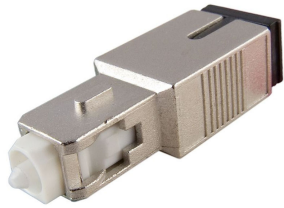

Fiber Optic Power Reducing Build Out Attenuator, singlemode SC/UPC, 3dB

- Designed to reduce or balance the power in passive optical networks
- Insertable between the connector and the adapter and therefore suited for distribution frames, cabinets and boxes
- High system flexibility because of wave-length independency and polarization insensitivity

Product Classification

Regional Availability	Latin America North America
Product Type	Fiber attenuator
Product Series	FOA

General Specifications

Interface	SC/UPC
------------------	--------

Outline Drawing

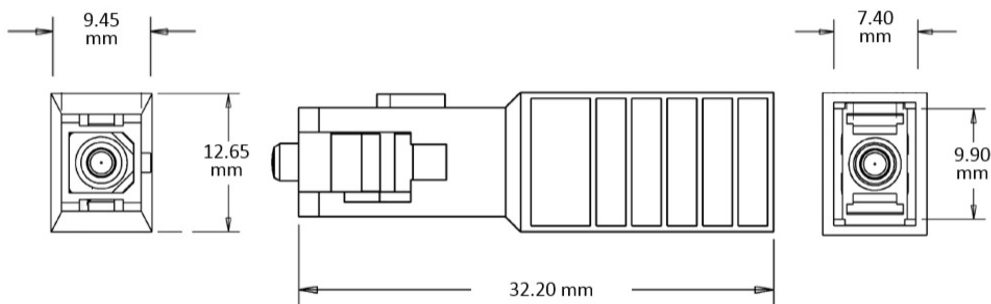

Optical Specifications

Fiber Mode	Singlemode
Fiber Type	G.652.D
Attenuation, nominal	3 dB

FOA-INSC03

Operating Wavelength	1430 – 1625 nm
Optical Components Standard	GR-910
Optical Power, maximum	250 mW
Return Loss, minimum	55 dB

Environmental Specifications

Operating Temperature	-40 °C to +75 °C (-40 °F to +167 °F)
Storage Temperature	-40 °C to +80 °C (-40 °F to +176 °F)

Regulatory Compliance/Certifications

Agency	Classification
CHINA-ROHS	Above maximum concentration value
REACH-SVHC	Compliant as per SVHC revision on www.commscope.com/ProductCompliance
ROHS	Compliant/Exempted
UK-ROHS	Compliant/Exempted

