

AT&T Fiber Distribution Frame Interbay Management Panel Cross-Connect Procedures

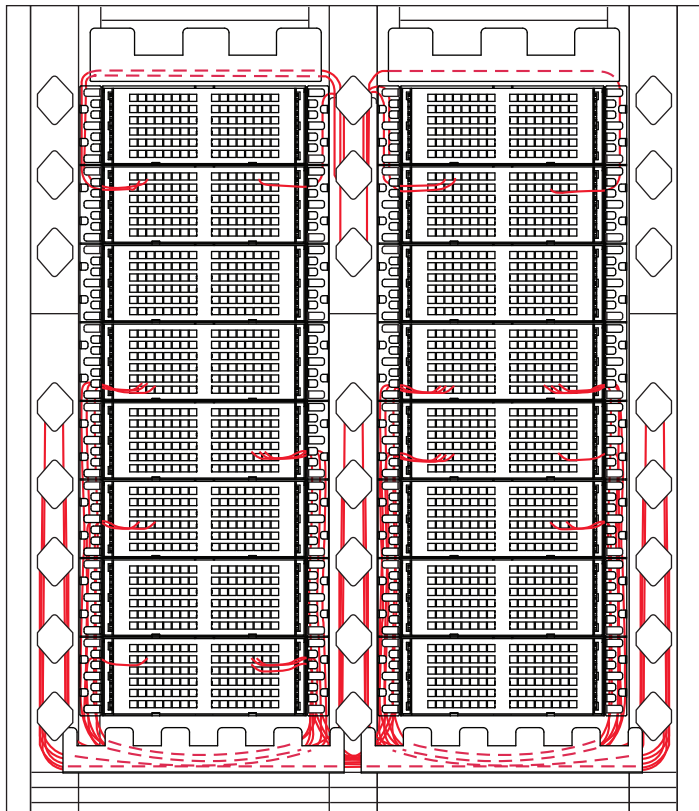

23821-A

Content	Page(s)
1. Introduction	3
2. Recommended Jumper Lengths	5
3. Cross-Connecting Procedures for Lower Route	6
4. Multibay Cross-Connecting Procedures for Lower Route	
• Between Adjacent Bays in a Multibay Lineup	
– Connecting Ports on the Outside Edge of Adjacent Bays	9
– Connecting Ports on the Same Side of Adjacent Bays	10
– Connecting Ports on the Inside Edge of Adjacent Bays	11
5. Cross-Connecting Procedures for Upper Route	12
6. Multibay Cross-Connecting Procedures for Upper Route	15
7. Fiber Optic Terminal (FOT) Jumper Routing	16
8. Cross-Aisle Routing	17

1. Introduction

This routing guide is intended for AT&T for the best cable management within bay lineups using CommScope FDF with an upper and lower trough. Minimum jumper length in all cases is 2m (approximately 6 ft.) to prevent intermodule noise. Do not use this procedure if upper trough is not present or for non-ADC FDF bay configurations.

CommScope Assistance

<http://www.commscope.com/SupportCenter>

Bay Zoning Map

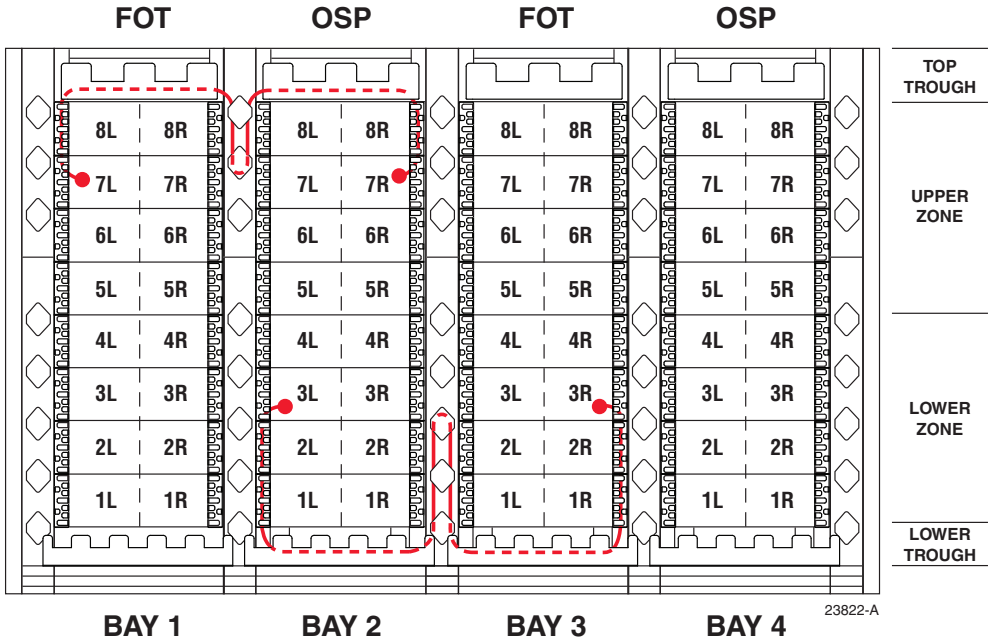

23822-A

1. **Locate Origination and Destination points on Zone Map.**
2. **If EITHER Origination OR Destination is in a lower zone (1L, 1R, 2L, 2R, 3L, 3R, 4L, 4R, 5L, 5R), use procedure on page 6, Cross-Connecting Procedures for Lower Route.**
3. **If BOTH Origination AND Destination is in an upper zone (6L, 6R, 7L, 7R, 8L, 8R, 9L, 9R), use procedure on page 12, Cross-Connecting Procedures for Upper Route.**

2. Recommended Jumper Lengths

Lower Trough

NUMBER OF LOWER TROUGHS	1	2	3	4	5	6	7	8	9	10	11	12
REQUIRED PATCHCORD LENGTH (M)	4	5	5	6	7	8	9	9	10	11	12	13

Upper Trough

NUMBER OF UPPER TROUGHS	1	2	3	4	5	6	7	8	9	10	11	12
REQUIRED PATCHCORD LENGTH (M)	3	4	4	5	6	7	8	8	9	10	11	12

3. Cross-Connecting Procedures for Lower Route

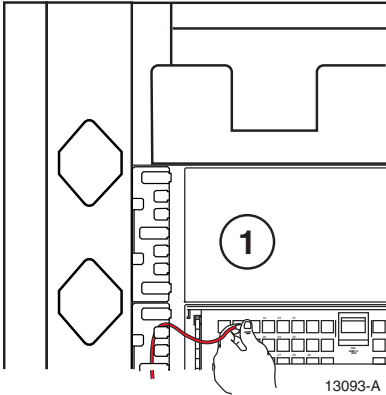

- 1 **TERMINATE** one end of the patchcord at the appropriate port.

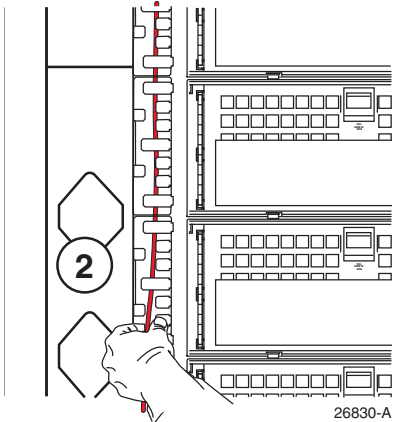

- 2 **ROUTE** the patchcord through the vertical cable guides to the lower trough.

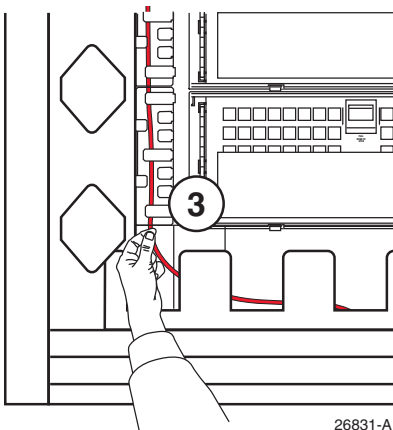

- 3 **PLACE** the patchcord in the lower trough.

3. Cross-Connecting Procedures for Lower Route, continued

- 4** ROUTE the unterminated end of the patchcord to the second connection port.

NOTE: Be sure to leave the extra patchcord slack in the lower trough.

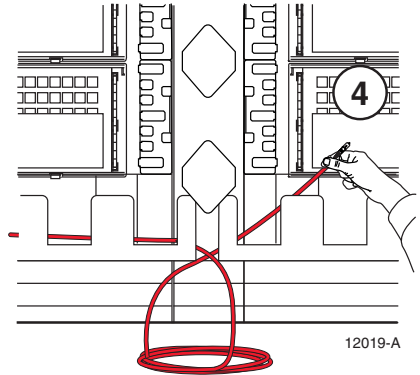

- 5** TERMINATE the second end of the patchcord to the appropriate port.

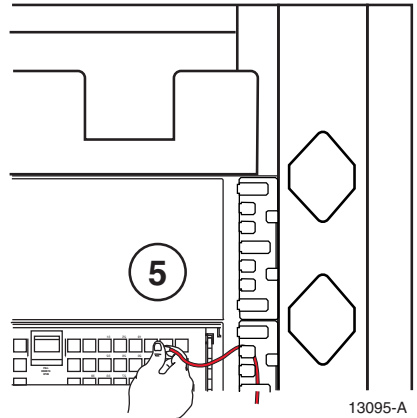

- 6** ROUTE the second end of the patchcord through the vertical cable guides to the lower trough.

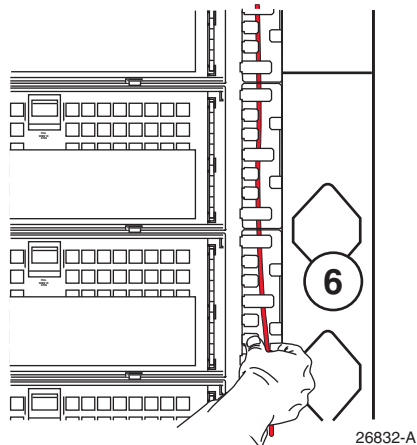

3. Cross-Connecting Procedures for Lower Route, continued

- 7 LOOP the patchcord slack, located in the lower trough, over the appropriate interbay management spool.

NOTE: See appropriate application drawing located within this user manual for recommended specific cable routings.

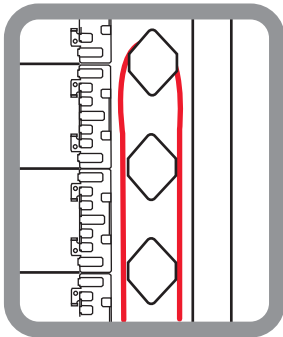

CORRECT ROUTING

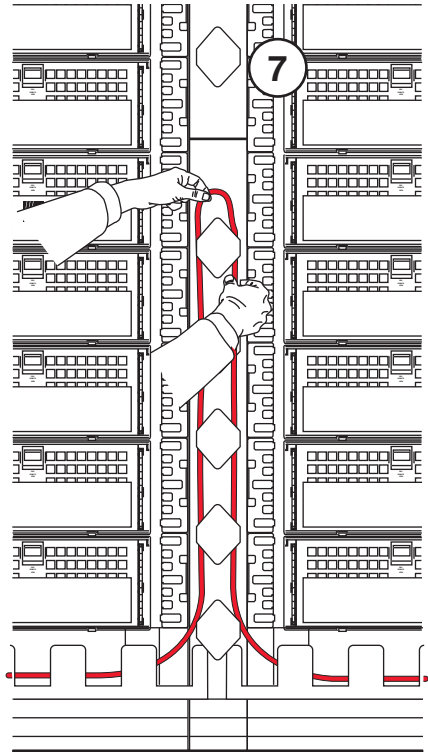

DO NOT WRAP PATCH CORD MULTIPLE TIMES AROUND SAME SPOOL

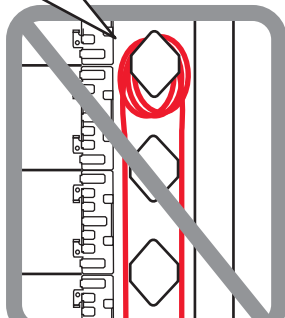

DO NOT WEAVE PATCH CORD AROUND SPOOLS

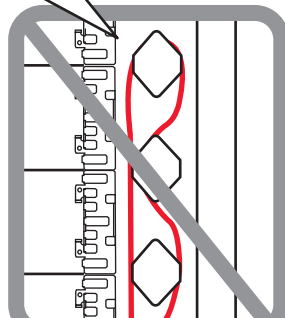

00000 A

4. Multibay Cross-Connecting Procedures for Lower Route

Between Adjacent Bays in a Multibay Line Up

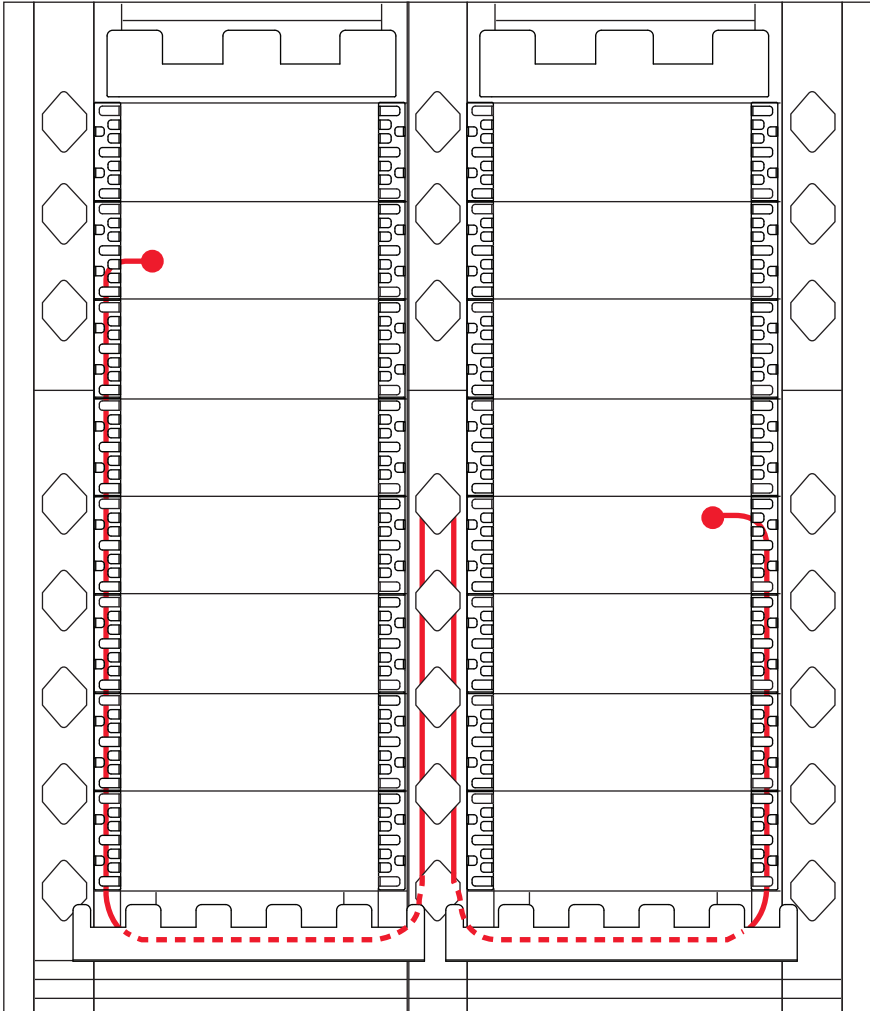

23823-A

**Connecting Ports on the Outside Edge
of Adjacent Bays**

4. Multibay Cross-Connecting Procedures for Lower Route, continued

Between Adjacent Bays in a Multibay Line Up

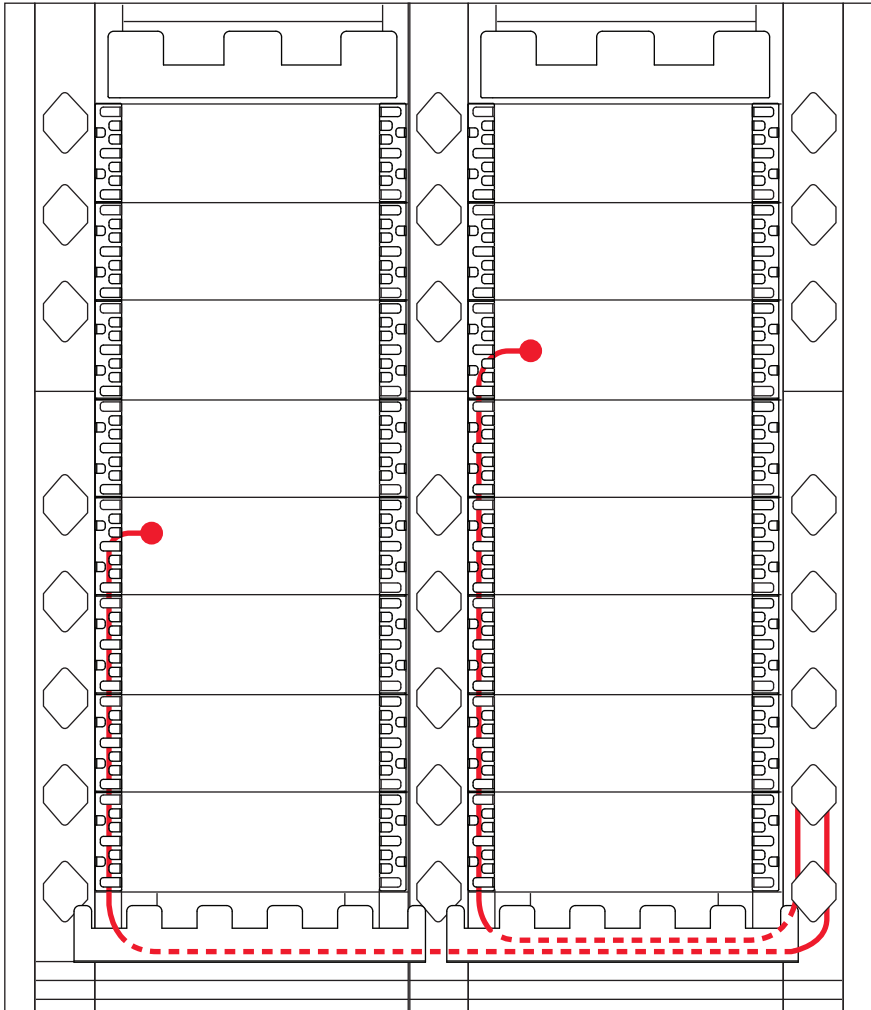

23824-A

Connecting Ports on the Same Side of Adjacent Bays

4. Multibay Cross-Connecting Procedures for Lower Route, continued

Between Adjacent Bays in a Multibay Line Up

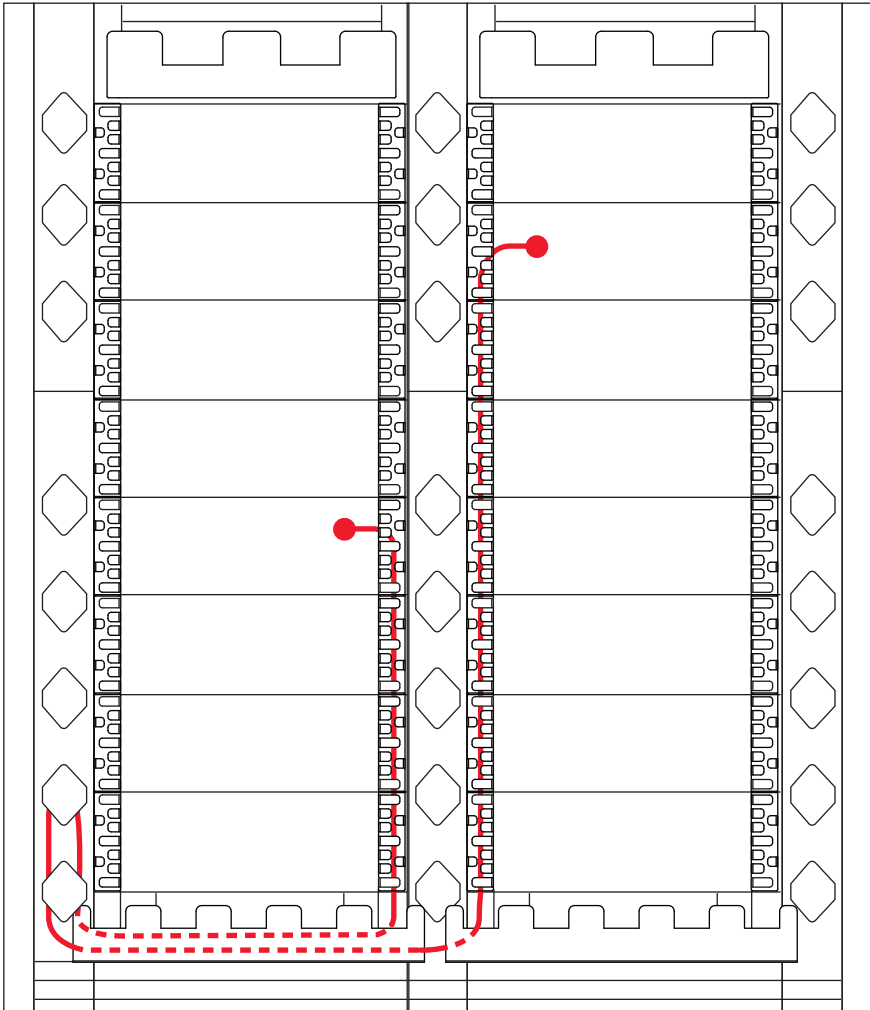

Connecting Ports on the Same Side of Adjacent Bays

23825-A

5. Cross-Connecting Procedures for Upper Route

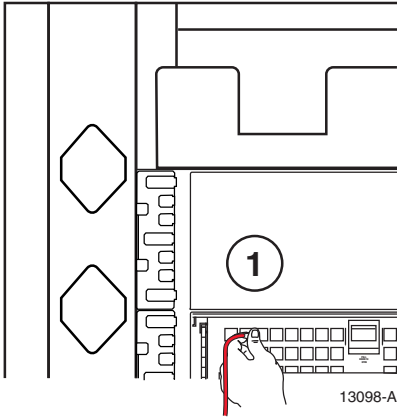

- 1 **TERMINATE** one end of the patchcord at the appropriate port.

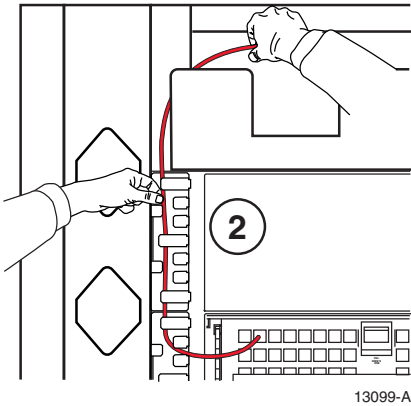

- 2 **ROUTE** the patchcord through the vertical cable guides to the upper trough.

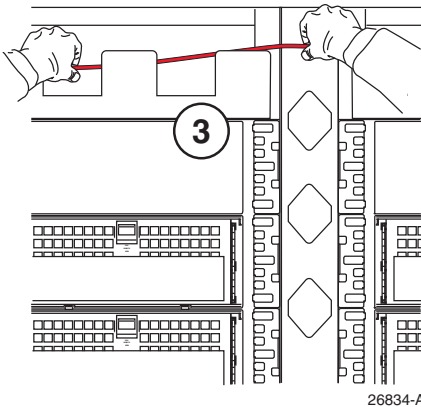

- 3 **PLACE** the patchcord in the upper trough.

5. Cross-Connecting Procedures for Upper Route, continued

- 4** ROUTE the unterminated end of the patchcord to the second connection port.

NOTE: Be sure to leave the extra patchcord slack in the upper trough.

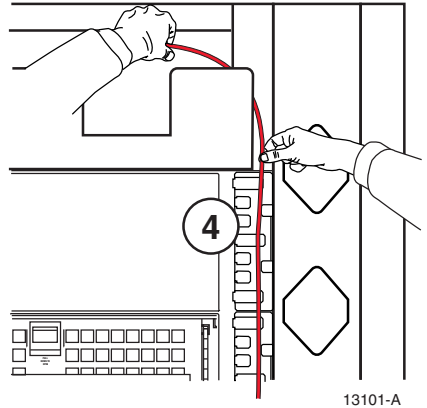

13101-A

- 5** TERMINATE the second end of the patchcord to the appropriate port.

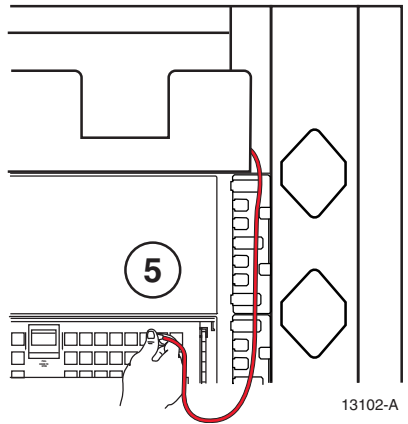

13102-A

- 6** ROUTE the second end of the patchcord through the vertical cable guides to the upper trough.

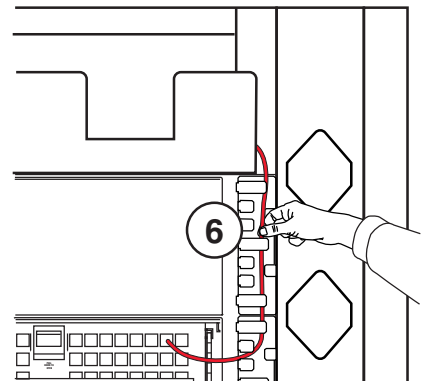

13103-A

5. Cross-Connecting Procedures for Upper Route, continued

- 7 LOOP the patchcord slack, located in the upper trough, under the appropriate interbay management spool.

NOTE: See appropriate application drawing located within this user manual for recommended specific cable routings.

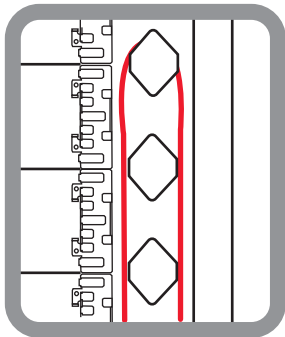
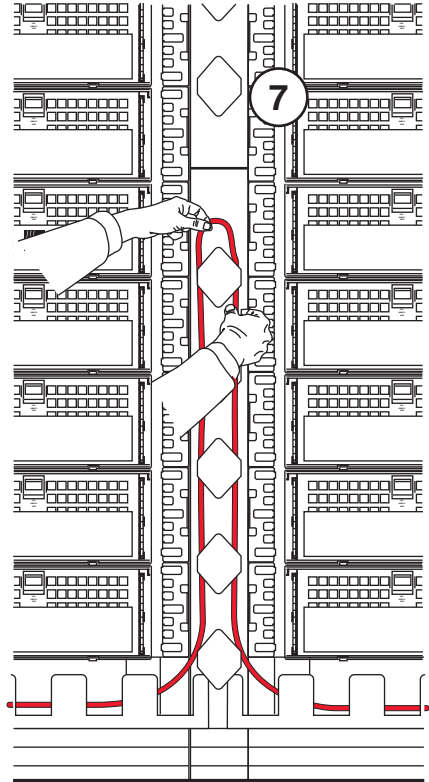

CORRECT ROUTING

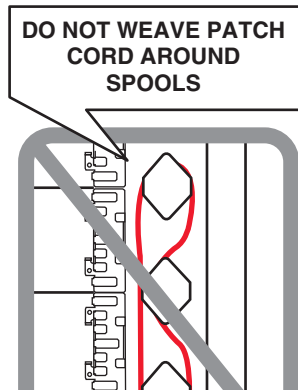
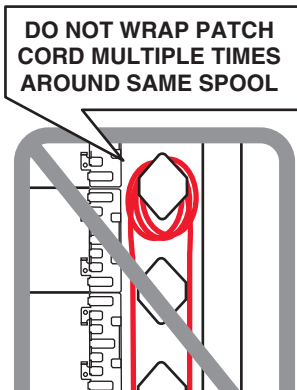

6. Multibay Cross-Connecting Procedures for Upper Route

Between Adjacent Bays in a Multibay Line Up

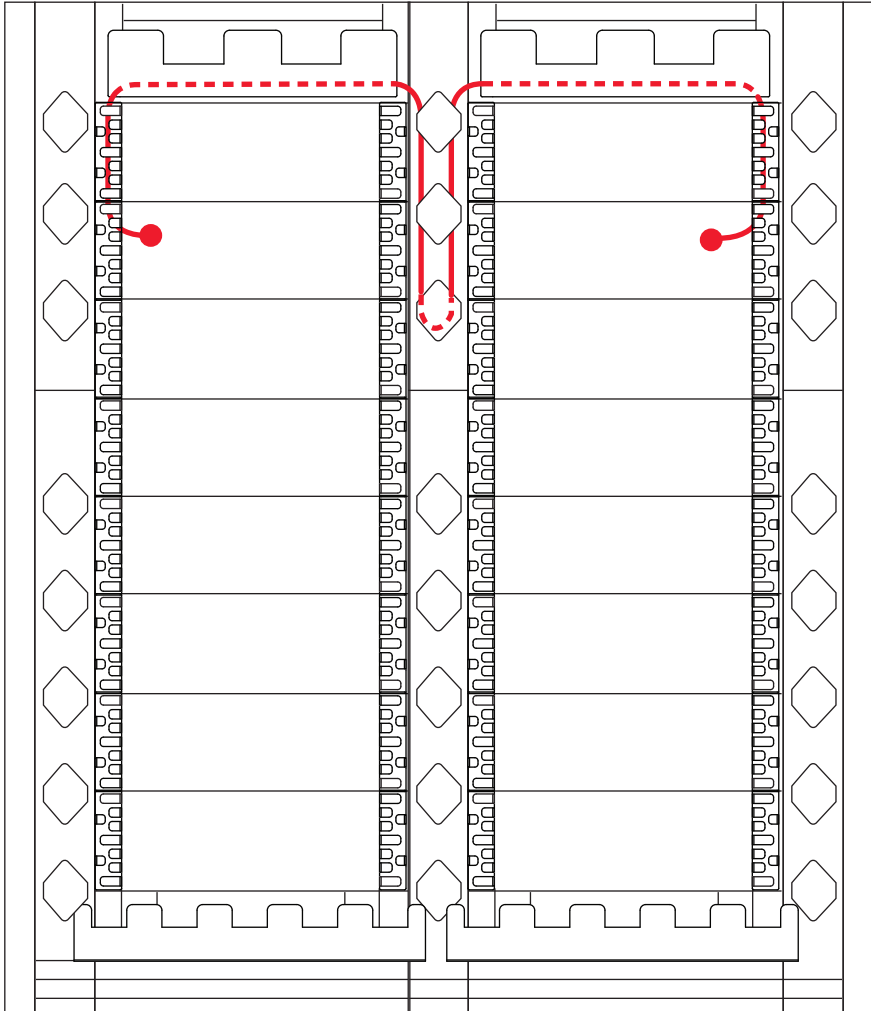

**Connecting Ports on the Outside Edge
of Adjacent Bays**

23826-A

7. Fiber Optic Terminal (FOT) Jumper Routing

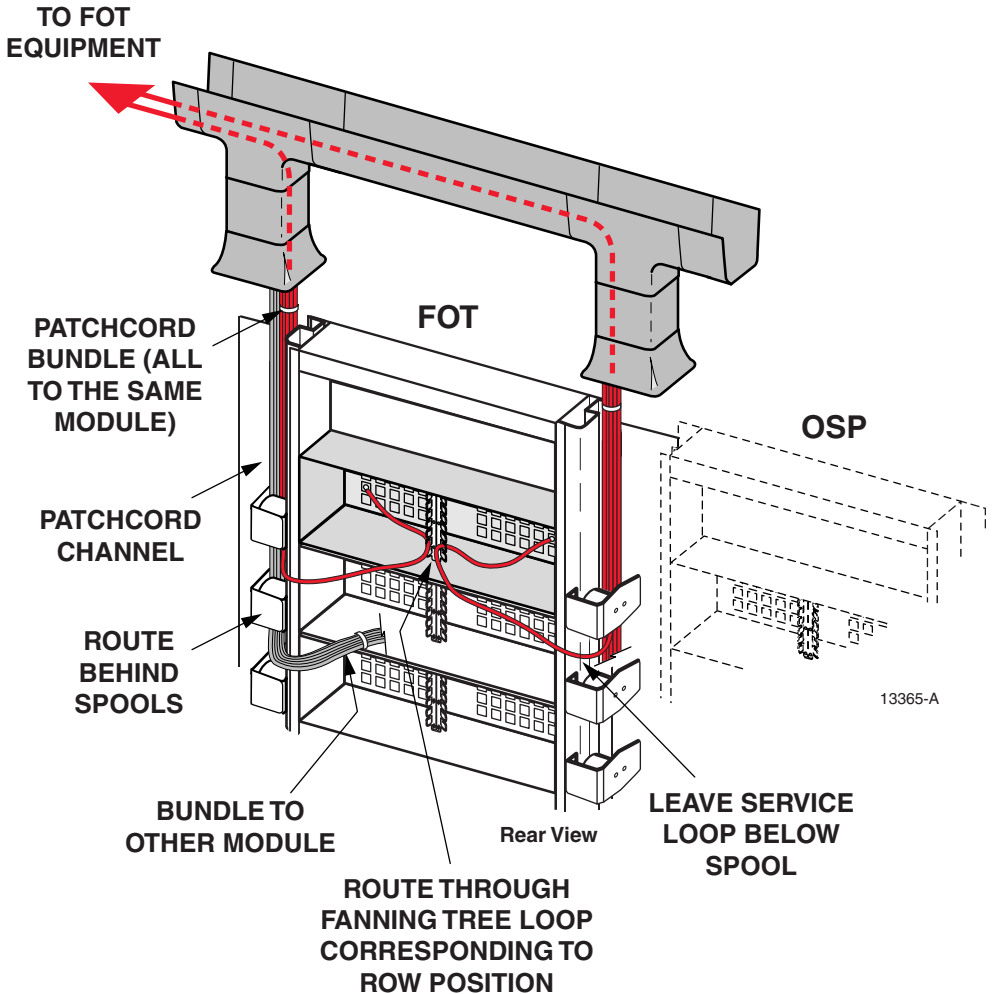

NOTE:
Work from the top down. Arrange bundles inside to outside in channel.

8. Cross-Aisle Routing

Jumpers may be routed from an FDF frame to another FDF frame on the other side of an aisle using an CommScope overhead X-aisle trough system. When using such a system, take up slack at the termination frame, as shown. Routing may be from front to front, front to rear, or rear to rear. (Rear routing is not shown, but the same principle applies.) For overhead routing details, see the reverse of this card.

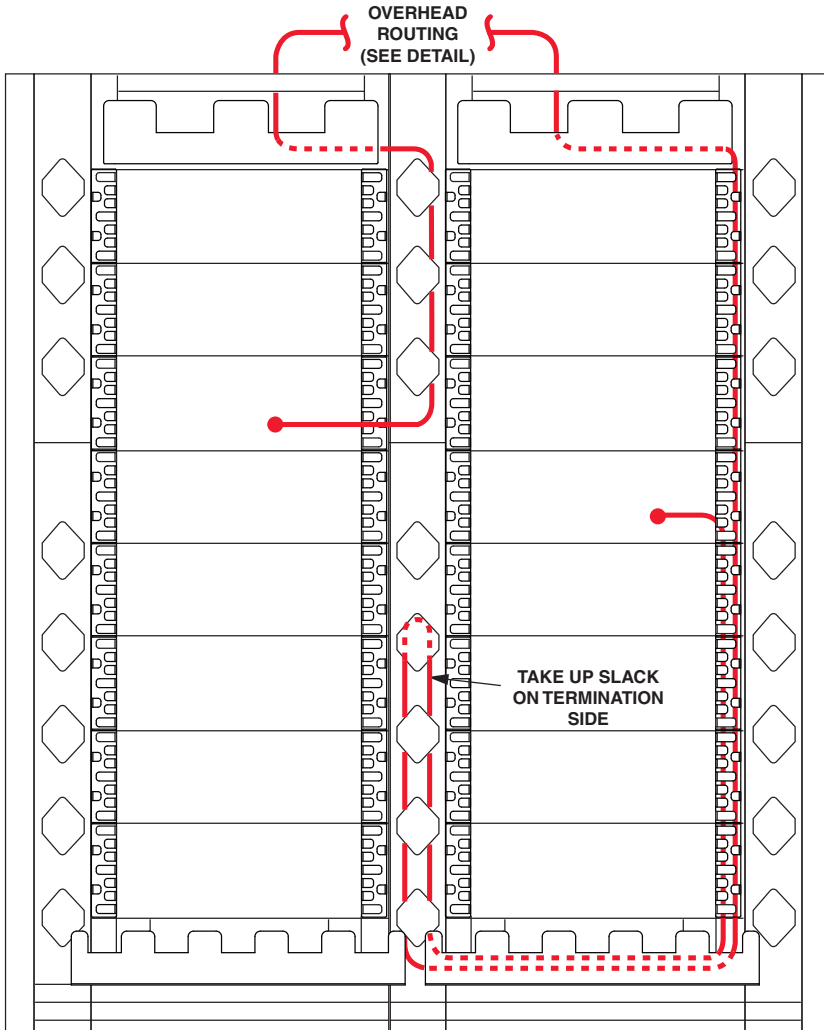

23962-A

8 Cross-Aisle Routing (Continued)

Within the overhead trough, route the jumpers so as to minimize sharp bends. Always take the route with the least sharp bend.

Ensure that radius limiters have been installed correctly at the inside and outside corners shown in the illustration.

