

## Installation Guidelines - – HELIAX® FiberFeed® Hybrid Solutions

### Fiber/Copper Cables: RFA808, RFA810, RFA812, RFA412

#### Related Support and Learning Opportunities Offered by the CommScope Infrastructure Academy

The insights and expertise contained in this manual represent just one small part of Andrew Solutions global learning initiative. Few industries are evolving as quickly as wireless communications. Every technological innovation impacts what happens in the field. Our customers look to the CommScope Infrastructure Academy to make sure their technicians and installers are well trained, well-prepared, and well-educated to take advantage of opportunities as they evolve. To access a course, go to [www.commscopetraining.com/coursecatalog.php](http://www.commscopetraining.com/coursecatalog.php), course #6107

#### Field Engineering Services (FES)

Support services, such as our Field Engineering Services (FES) Group gives Andrew Solutions' customers access to technical support where and when it is needed the most — in the field. The FES team is staffed by an expert team of technicians who, in turn, are supported by some of the brightest and most experienced product line managers. With all of this knowledge and support the FES offers our customers access to hands-on, specialized training classes.

<b>Section 1: Trunk Fiber Feeder Hoisting .....</b>	<b>02</b>
<b>Section 2: General Specifications / Fiber Jumpers.....</b>	<b>04</b>
<b>Section 3: Trunk to Enclosure Connection .....</b>	<b>06</b>
<b>Section 4: Breakout Procedure / LC Connection Considerations .....</b>	<b>07</b>
<b>Section 5: Cleaning / Inspecting .....</b>	<b>08</b>
<b>Section 6: BBU Breakout / Hanger- Grommet.....</b>	<b>09</b>
<b>Section 7: Estimating Trunk Length / Excess Cable handling .....</b>	<b>10</b>
<b>Section 8: Installation Check List and Fiber Troubleshooting .....</b>	<b>12</b>

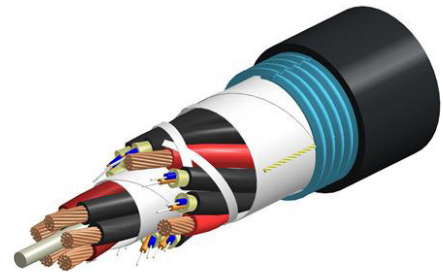

#### Customer Service Center

United States and Mexico 1-800-255-1479 or 1-888-235-5732  
International: +1-779-435-8579

For the most current, up-to-date information on all our products and product information please visit our eCatalog section at [www.commscope.com](http://www.commscope.com).

## Hoisting Considerations

- In general this cable will handle similarly to coaxial cable, and similar installation techniques apply. All cables are individually serialized, be sure to write down the cable serial number for future reference.
- Leave the protective sock around the fiber tails and power conductors during hoisting and securing the cable.
- Be sure that the Direct breakout is not damaged by attachment of a hoisting grip or during the hoisting process. Attach a hoisting grip on the jacketed cable no less than .3 m (1 ft) below the fiber breakout point. Prevent the fiber tails and power conductors from undue movement during hoisting by securing the protective sock with tie ropes every 1 m (3 ft) to the hoisting line.
- During hoisting ensure that there is a free path and that the cable, and especially the end of the pulling sock will not be snagged on tower members or other obstacles.
- Installation temperature range is -22 F to 158 F (-30 C to +70 C).
- Minimum cable bend radii can be found on-line in our eCatalog section at [www.commscope.com/andrew](http://www.commscope.com/andrew).
- Maximum cable tensile load can be found on-line in our eCatalog section at [www.commscope.com/andrew](http://www.commscope.com/andrew).
- **CommScope Lace-Up Hoisting Grip 19256B-C required for HFE trunk-series installations.**
- **Hoisting Grip should be anchored to the support structure after the hangers are installed.**
- During final connections to RRU, do not bend the fiber ends tighter than 30 mm (1.2 in) bend radius or you take the risk of breaking the glass fibers.

 Hybrid Fiber Cables weigh more than traditional coaxial cables. Be sure to follow proper hoisting and attachment procedures.

## Hoisting Recommendations

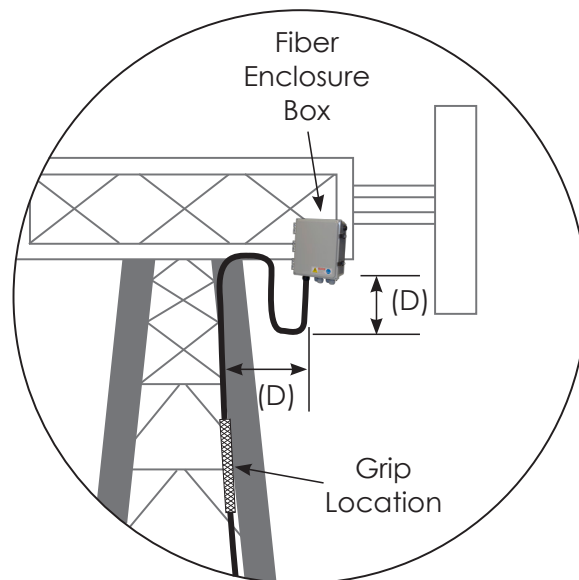

**Reminder:** Plan grip location by measuring distance (D) from Fiber Enclosure Box to tower support member.

**Hoisting Considerations**

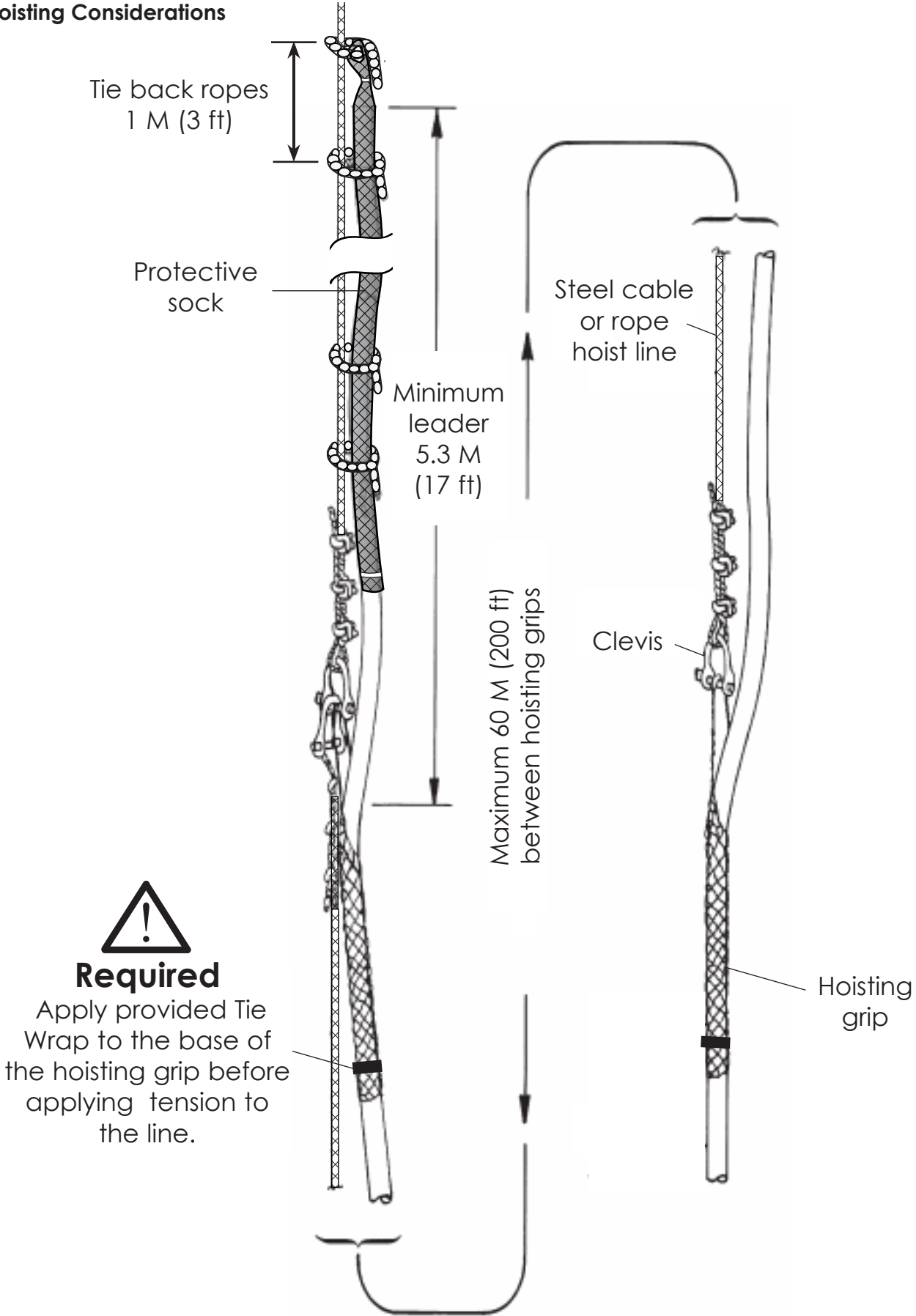

**Required**

Apply provided Tie Wrap to the base of the hoisting grip before applying tension to the line.

**General Specifications**

Cable Type	RFA808-16S14-XXX	RFA810-16S14-XXX	RFA812-16S14-XXX
Brand	HELIAX® FiberFeed®	HELIAX® FiberFeed®	HELIAX® FiberFeed®
Center Conductor Gauge	8 AWG	10 AWG	12 AWG
Conductors, quantity	8	8	8
Total Fiber Quantity	16	16	16
Armor Type	Corrugated aluminum	Corrugated aluminum	Corrugated aluminum
Fiber Type	TeraSPEED® Singlemode fiber	TeraSPEED® Singlemode fiber	TeraSPEED® Singlemode fiber

**Dimensions**

Cable Weight	1130.0 kg/km   760.0 lb/kft	750.0 kg/km   510.0 lb/kft	516.0 kg/km   347.0 lb/kft
Diameter Over Jacket	27.90 mm   1.10 in	23.50 mm   0.93 in	19.81 mm   0.78 in
Breakout Length, Fiber, end 1	900 mm   35 in	900 mm   35 in	900 mm   35 in
Breakout Length, Power, end 1	775 mm   31 in	775 mm   31 in	775 mm   31 in
Breakout Length, Fiber, end 2	2000 mm   79 in	2000 mm   79 in	2000 mm   79 in
Breakout Length, Power, end 2	2000 mm   79 in	2000 mm   79 in	2000 mm   79 in

**Physical Specifications**

Minimum Bend Radius, loaded	558.8 mm   22.0 in	469.9 mm   18.5 in	396.2 mm   15.6 in
Minimum Bend Radius, unloaded	279.4 mm   11.0 in	236.2 mm   9.3 in	198.1 mm   7.8 in
Tensile Load, long term, maximum	1068 N   240 lbf	801 N   180 lbf	801 N   180 lbf
Tensile Load, short term, maximum	3559 N   800 lbf	2669 N   600 lbf	2669 N   600 lbf

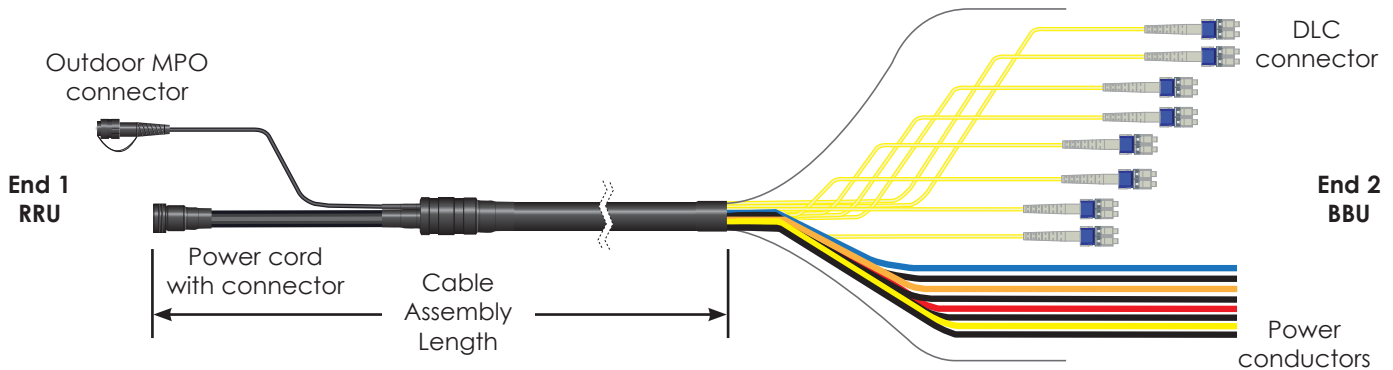

**Jumper Assemblies**

- The terminated fiber ends however are fragile and must be protected during installation. Leave the packaging around the fiber ends in place until ready to connect the jumper between junction box and RRU or BBU.
- DO NOT BEND THE FIBER ENDS (in the orange furcation tubes) TIGHTER THAN 1.18" (30mm) BEND RADIUS ELSE THERE IS A RISK OF BREAKING THE GLASS FIBERS.
- Attach the main cable securely to the structure or equipment using hangers and/or cable ties to prevent strain on connections from movement in wind or snow/ice conditions.
- Ensure the LC fiber connectors are seated firmly in panel in junction box or in equipment.
- All RRU ensure the weatherproof boots for both fiber and power connections and seated firmly in the radio frame.
- Shrink tube of the jumper should be 1" (25.40mm) inside of the Junction box.
- Installation temperature range is -22F to 158F (-30C to 70C).
- Minimum cable bend radii are 10.3" (265mm) loaded (with tension on the cable) and 5.2" (130mm) unloaded.
- Maximum cable tensile load is 350lb (1560N) short term (during installation) and 105lb (470N) long term.
- Standard lengths available are 6 feet, 12 feet and 20 feet - others are available on request.
- All jumpers are individually serialized, for immediate access to test results visit [www.commscope.com/webtrak/](http://www.commscope.com/webtrak/)

Tails:

Pre-Installed into the Junction Box: RFA412 series

**Huawei Radio**

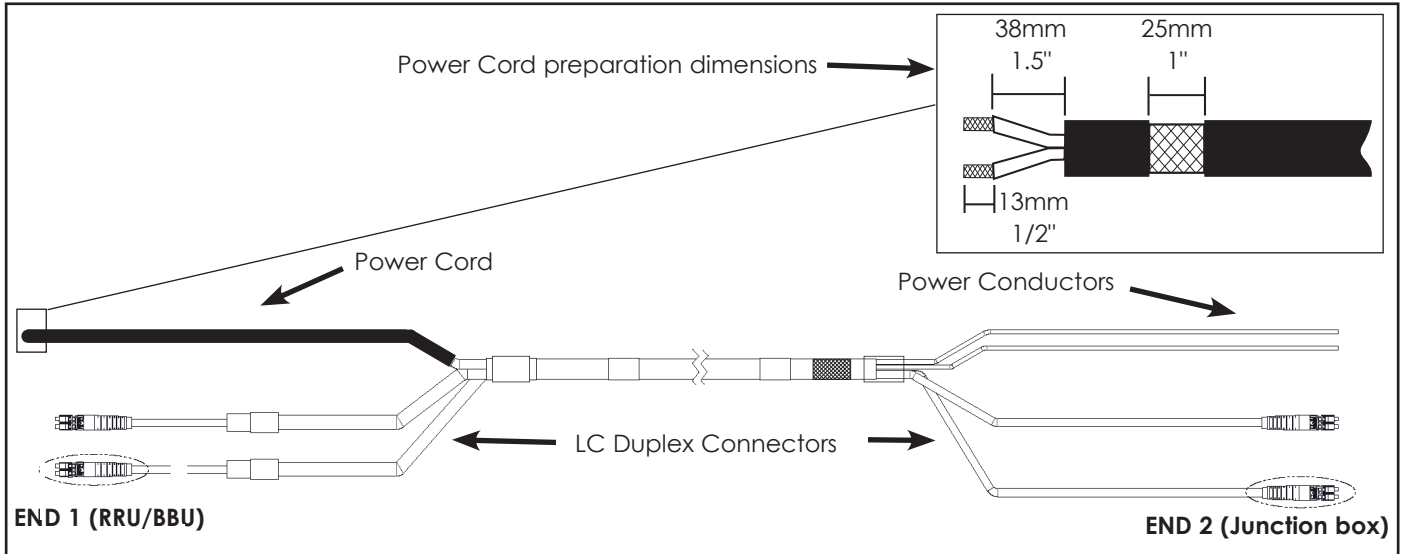

**Ericsson Radio**

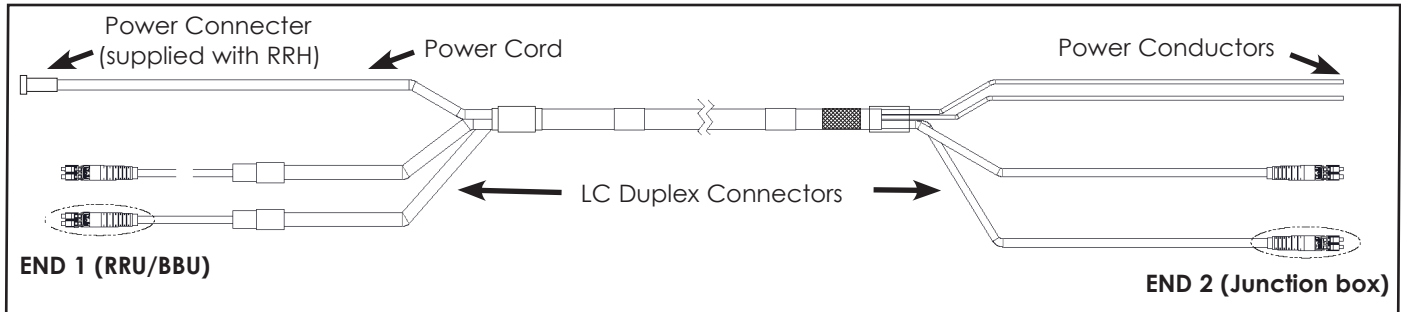

**NSN Radio**

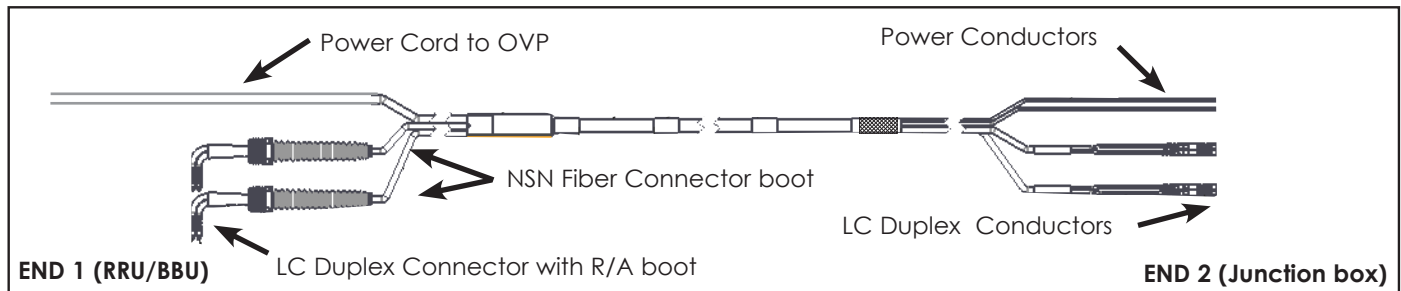

Trunk to Fiber Enclosure Connection

RFA808-16S14 series cables  
 RFA810-16S14 series cables  
 RFA812-16S14 series cables

FE-12104-ET-R4



Fiber MPO Connector      Power Connector

**1**

Remove dust caps. Power connector is keyed for proper installation. 1/4 turn to fully engage. To prevent damaging to the zinc-cobalt coating use a Strap Wrench to tighten the outdoor power connectors.

Part Number: FA-SW-101

**2**

Remove dust caps from the MPO connectors. Line-up white lines and 1/4 turn to fully engage.





**Breakout Procedure**

After the trunk cable has been installed and you are ready to make the final connection to the OVP box follow these steps for the removal of fiber protection tube.



1 Remove electrical tape from the trunk cable and corrugated protection tube



2 While holding the protection tube straight pull the tube away from cable.



3 After you have pulled the fiber and power conductors into the OVP box remove electrical tape from the trunk cable and remove clear tube for access to all optical connectors.

**LC Connectors and Adapter cleaning**

Clean exposed connector ferrule by lightly moistening lint-free wipe with fiber optic cleaning solution (or >91% isopropyl alcohol), and by applying medium pressure, first wipe against wet area and then onto dry area to clean potential residue from end face. Clean connector ferrule inside adapter by inserting lightly moistened cleaning stick with fiber optic cleaning solution (or >91% isopropyl alcohol) inside the adapter until contact is made with connector on opposite end. Rotate cleaning stick with medium pressure in one circular motion as it is pulled away from the adapter. Repeat process using dry cleaning stick.

**Caution:** Signal strength will be affected if end and sides of ferrule are not thoroughly cleaned. Discard cleaning sticks after each use. Do not turn cleaning sticks back and forth pressing against connector end face. This may cause scratches if large contamination is present. Always inspect connector end face for contamination after each cleaning.

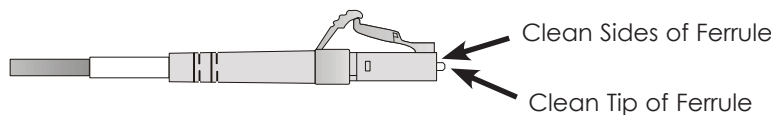

Clean adapter by inserting adapter cleaning stick (or fiber adapter sleeve brush) moistened with fiber optic cleaning solution (or >91% isopropyl alcohol) inside the adapter and gently pull out with twisting motion. Repeat process with a dry cleaning stick.

**Caution:** Do not try to clean adapter with a standard pipe cleaner. The sleeve inner diameter of LC adapters is too small. Do not try to clean the adapter with cleaning stick if a connector is mounted in one side. Discard cleaning sticks after each use.



**All in one cleaners**

Designed for cleaning the ferrule end faces of connectors

Open guide cap, insert connector into guide, push the outer shell to start cleaning the connector interface, a "click" sound indicates end of a cleaning process, repeat, close cap immediately after use.

**Caution:** Be careful not to slant the connector while inserting into the Guide cap. Do not overly exert force during insertion as this may cause damage to both the connector and the cleaner.

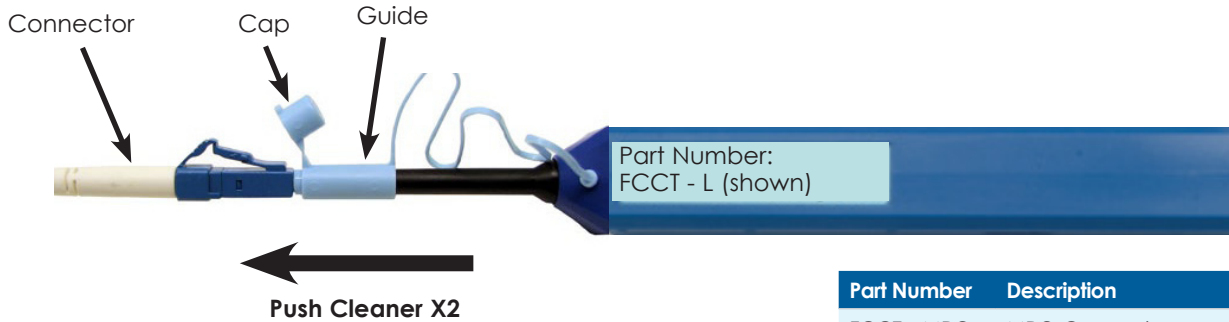

Part Number	Description
FCCT – MPO	MPO Connectors
FCCT – L	DLC & LC Connectors

**Inspecting**

There are 3 basic principles that are critical to achieving an efficient fiber optic connection:

1. Perfect Core Alignment
2. Physical Contact
3. Pristine Connector Interface



Scan to view video

Today's connector design and production techniques have eliminated most of the challenges to achieving core alignment and physical contact. What remains challenging is maintaining a pristine end-face. As a result, CONTAMINATION is the #1 reason for troubleshooting optical networks.

**Implementing the process of cleaning and inspecting before mating can reduce the time spent troubleshooting, optimize signal performance and prevent damage.**

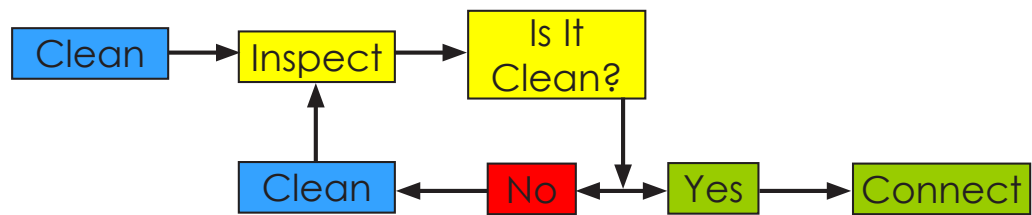

**Abrasive particles (i.e. rock dust) can cause permanent damage to the interface. If interface is scratched it cannot be repaired, it would need to be replaced.**

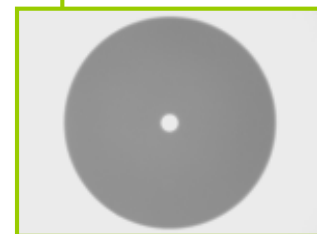
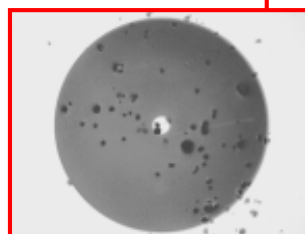



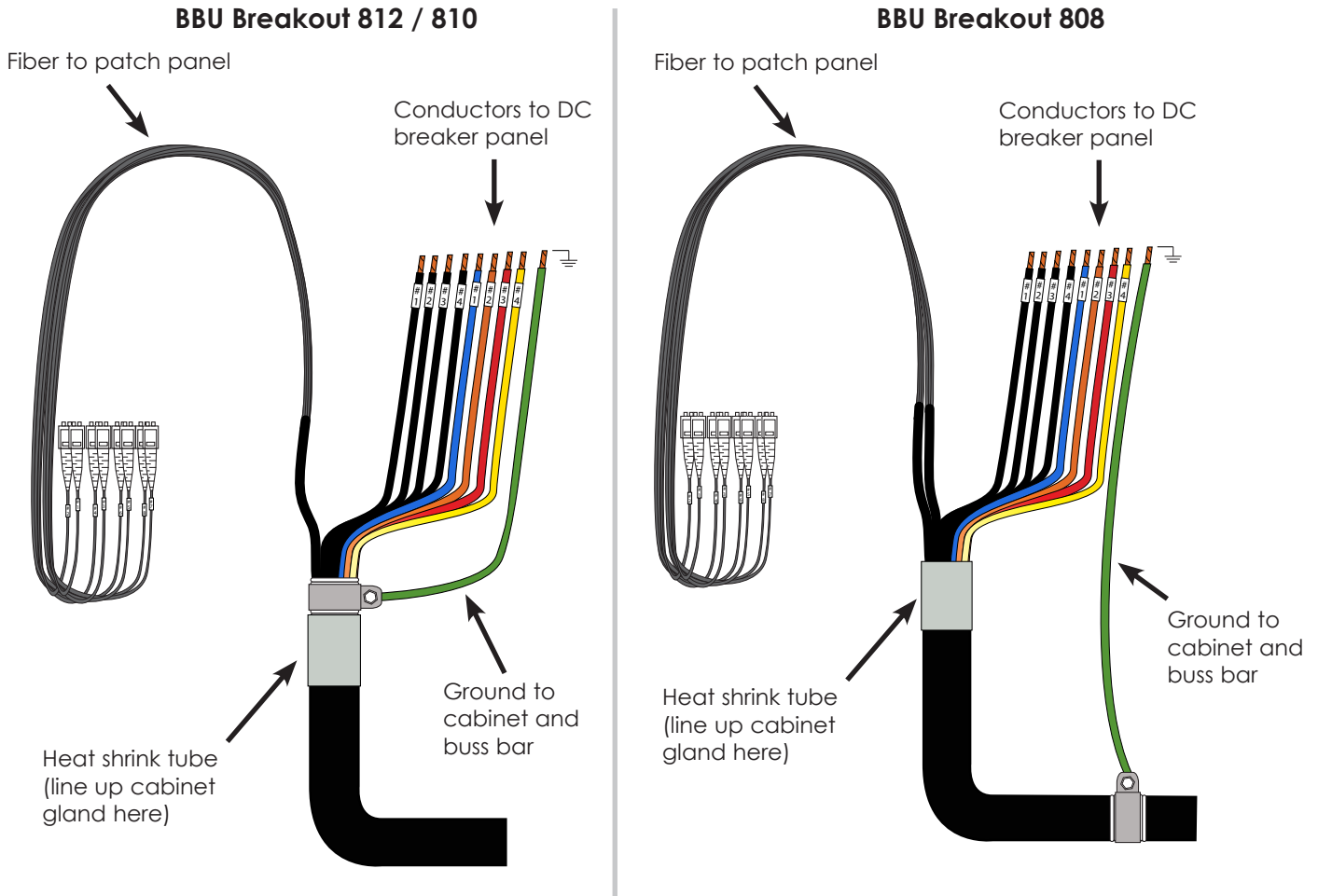

**Hanger**

Part Number	Description	Kit Includes
SHK-78-1-10	Single stack hanger for RFA808 series cables	10 Hangers
SHK-78-3-10	Tripple stack hanger for RFA808 series cables	10 Hangers
SHK-24-1-PV2	Single stack hanger for RFA810 series cables	10 Hangers
SHK-24-3-PV2	Tripple stack hanger for RFA810 series cables	10 Hangers
SHK-19-1-PV2	Single stack hanger for RFA812 series cables	10 Hangers
SHK-19-3-PV2	Tripple stack hanger for RFA812 series cables	10 Hangers

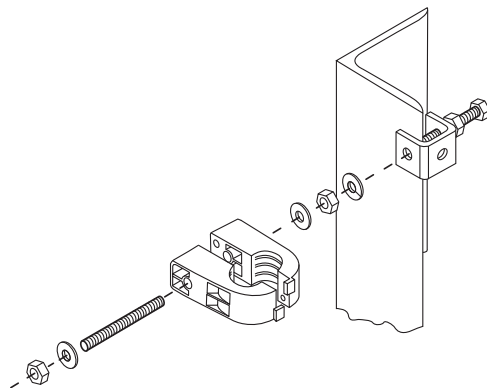
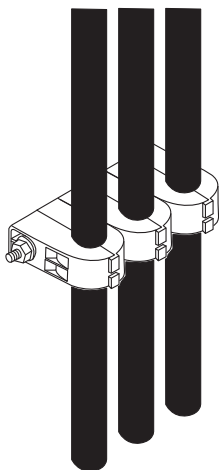

- 1 Hanger required every 1m (3ft)

**Estimating Trunk Length**

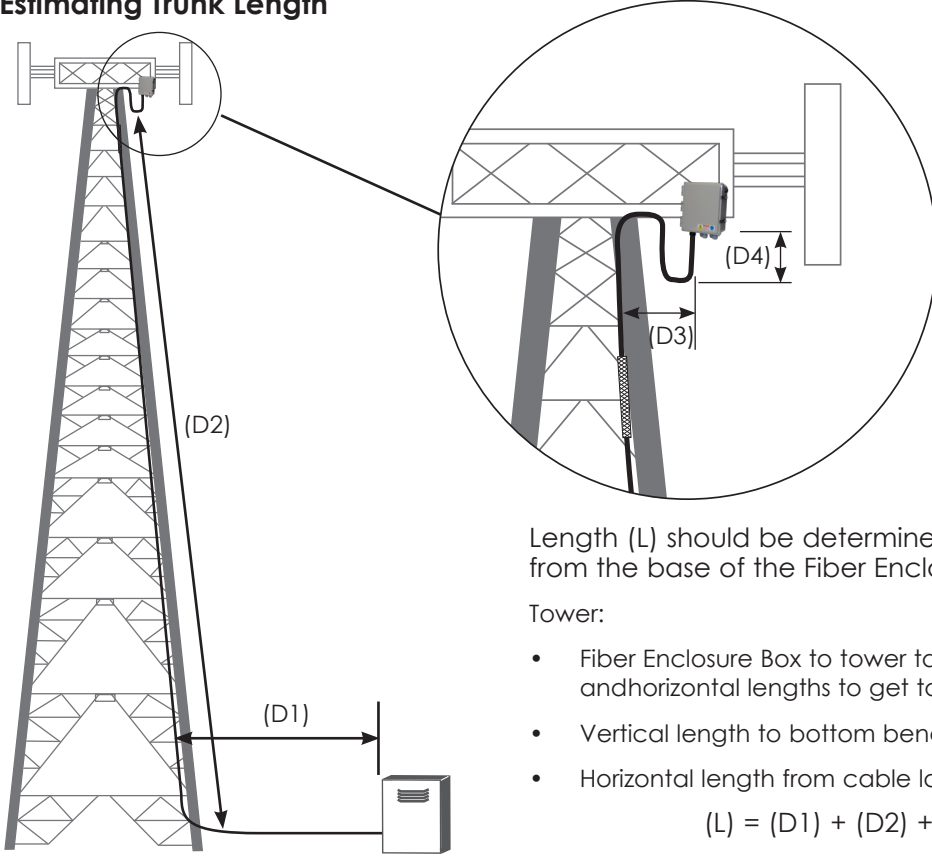

Length (L) should be determined by measuring the trunk cable from the base of the Fiber Enclosure Box to the Cabinet.

Tower:

- Fiber Enclosure Box to tower taking in account vertical and horizontal lengths to get to the cable ladder
- Vertical length to bottom bend towards cabinet
- Horizontal length from cable ladder to cabinet base

$$(L) = (D1) + (D2) + (D3) + (D4)$$



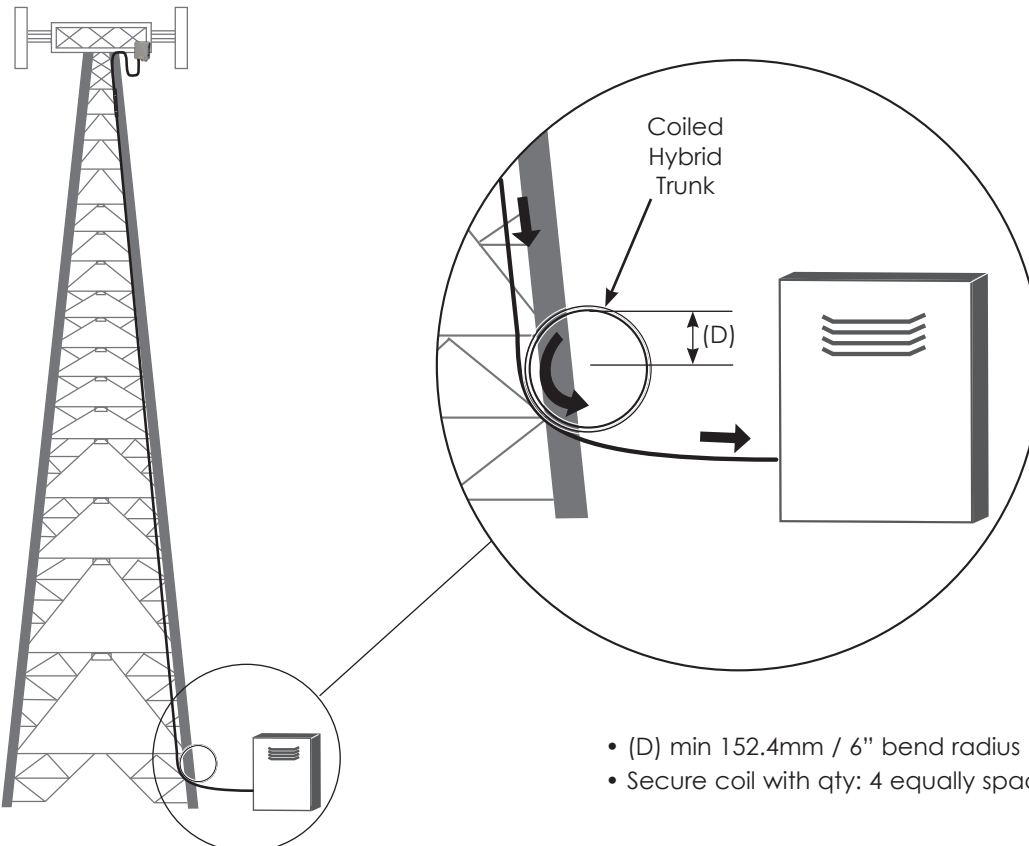





**Excess Cable Handling**

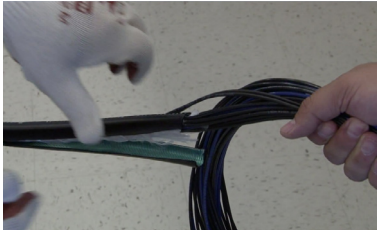

- (D) min 152.4mm / 6" bend radius
- Secure coil with qty: 4 equally spaced 50 lb UV rated tie wraps

**Excess Cable Management**

If length of cable installed needs to be adjusted you can split the cable at the BBU end using the process below and then coiling the excess fiber subunits in a storage box. Patch Panel Kits are available to manage any excess fiber length in the breakouts at the BBU.

<p><b>1. Mark cutback length</b></p> 	<p><b>2. Notch armor using flush cutter in-line with Kevlar strings</b></p> 
<p><b>3. Place rip cord in notches'</b></p> 	<p><b>4. Pull rip cord parallel to cable (while supporting breakout)</b></p> 
<p><b>5. Stop at length marker</b></p> 	<p><b>6. Separate armor</b></p> 
<p><b>7. Cut armor using side cutter</b></p> 	<p><b>8. Remove water blocking tape</b></p> 
<p><b>9. Remove excess rip cord</b></p> 	<p><b>10. Apply electrical tape to protect breakout</b></p> <p><b>NOTE:</b> Remember to slide identifier labels down the power conductors before trimming the cable to it's final length</p> 



Cable Splitter tool  
Part Number:  
FA-RCRT-PD



Excess Fiber  
storage Box  
Part Number:  
FE-14126-E



Fiber management  
tray, Part Number:  
HFF-SMPK-SS-24



Scan to  
view video



Click here  
for video

**Installation Check List**

- Proper Fiber Connections keeping sectors consistent
- Double check all Electrical Terminals for proper torque, screw in all empty terminals
- Double check all Box compression fittings for proper torque (per installation bulletin)
- Proper grounding of both Boxes with 6 AWG (min) to 2 AWG (max) cables
- Double Check all outdoor RRU Connections (fiber, power and connectors) are properly seated
- Latch top and bottom of boxes – both latched
- Properly support all jumpers to prevent strain on fiber during severe weather
- Cable serial numbers have been documented in the closeout paperwork and a copy has been left on-site

**Fiber Troubleshooting**

- Clean First! Clean optical end face with appropriate all in one cleaner. Clean all connector end faces
- Visually inspect end face for residual dirt and damage
- Avoid migration of contaminations from one connector to another
- Check continuity by using LED or lazer light source from one end face and look for light from other end to identify any broken fiber (Do not look directly at cable with lazer source)
- Check end face again for cleanliness before attachment. If needed, clean again
- Scan QR code to visit Webtrak online for fast, easy access to test data or download the cTrak app from [www.commscope.com/apps](http://www.commscope.com/apps)



[www.commscope.com/andrew](http://www.commscope.com/andrew)

Visit our Web site or contact your local CommScope representative for more information

© 2014 CommScope, Inc. All rights reserved.

All trademarks identified by ® or ™ are registered trademarks or trademarks, respectively, of CommScope, Inc.

This document is for planning purposes only and is not intended to modify or supplement any specifications or warranties relating to CommScope products or services.