

# Installation Instructions

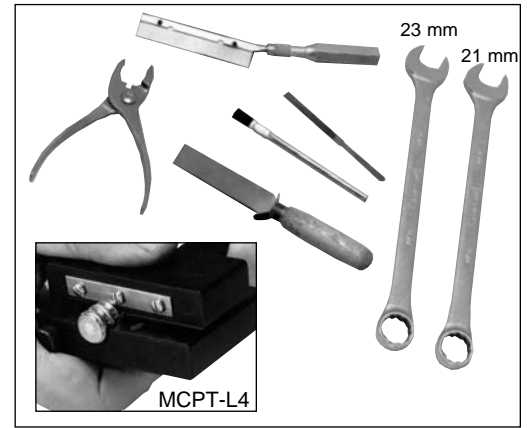

7-16 DIN Connectors  
for 1/2" HELIAX® Coaxial Cable

Andrew Institute offers installation training.



**1**

Trim cable jacket.  
Recortar la envuelta del cable.  
Coupez la gaine du câble.  
Kabelmantel abziehen.  
Retire a capa do cabo.

切整電纜外皮

**2**

Add O-ring, grease, and clamping nut.  
Añadir la junta tórica, la grasa y la tuerca sujetadora.  
Mettez en place le joint torique, de la graisse et l'écrou de serrage.  
O-Ring und Klemmutter vor Montage einfetten.  
Coloque o anel O ring, graxa e a porca de aperto.

加 O 型圈，油脂和緊固螺母

**3**

Cut outer conductor.  
Cortar el conductor externo.  
Coupez le conducteur extérieur.  
Außenleiter zurückschneiden.  
Corte o condutor externo.

切外導體

**4**

Remove foam and adhesive.  
Retirar el material de espuma y el adhesivo.  
Enlevez la mousse et l'adhésif.  
Verschäumung und Klebeband entfernen.  
Remova a espuma e o adesivo.

去除泡沫塑料和粘潔劑

**5**

Trim inner conductor. Remove debris.  
Cortar el conductor interno. Retirar los restos.  
Coupez le conducteur intérieur. Enlevez les débris.  
Innenleiter abschneiden. Metallspäne entfernen.  
Limpe o condutor interno. Remova os detritos.

切整內心導體。去除殘渣

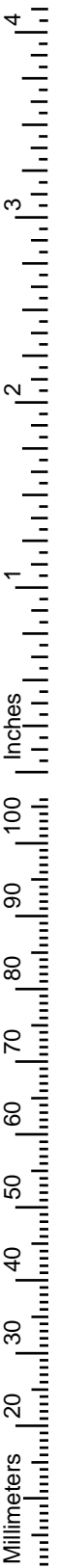

5

Compress foam.  
 Comprimir el material de espuma.  
 Comprimez la mousse.  
 Verschäumung zusammendrücken.  
 Comprima a espuma.

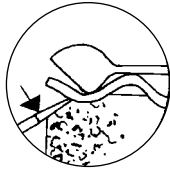

壓緊泡沫塑料

6

Flare outer conductor, examine flare, remove debris  
 Acampanar el conductor externo, examinar la forma de campana y retirar los restos.  
 Evasez le conducteur extérieur, examinez l'évasement et enlevez les débris.  
 Außenleiter aufweiten, Öffnung prüfen und Metallspäne entfernen.  
 Flangear o conductor externo, examinar o flangeamento e remover os detritos.

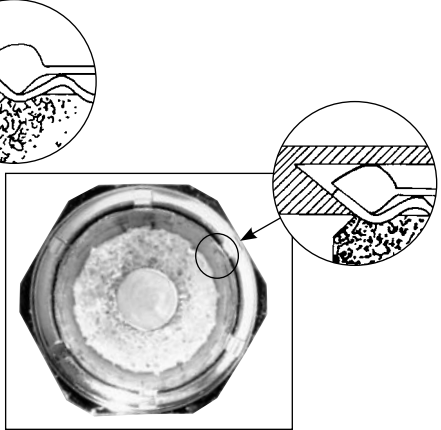
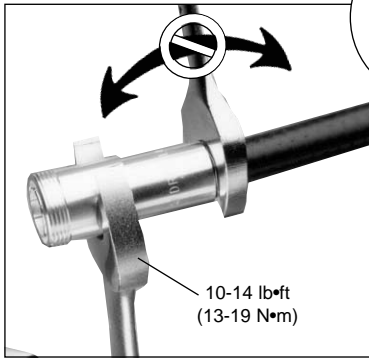

擴張外導體，檢查擴張表面，去除殘骸。

7

Add O-ring and grease. Reassemble connector.  
 Añadir la junta tórica y grasa. Montar nuevamente el conector.  
 Mettez en place le joint torique et graissez. Réassemblez le connecteur.  
 O-Ring vor Montage einfetten. Steckverbindung wieder zusammenbauen.  
 Coloque o anel em O ring e graxa. Reinstale o conector.

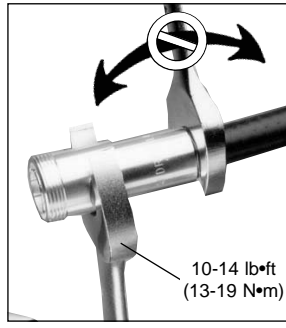
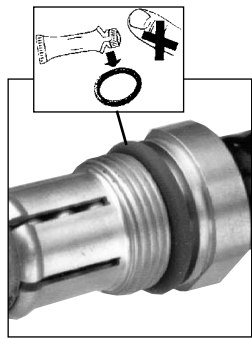

Coupling torque.  
 Par de acoplamiento.  
 Couple de serrage.  
 Anschlussdrehmoment.  
 Torque de conjugação.

配合扭矩

18-22 lb•ft  
 (25-30 N•m)

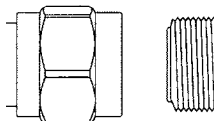

加O型圈和油脂。重新裝配接頭

	表一 有毒有害物质或元素名称及含量标识格式					
	有毒有害物质或元素					
部件名称 (Part Name)	铅 (Pb)	汞 (Hg)	镉 (Cd)	六价铬 (Cr6+)	多溴联苯 (PBB)	多溴二苯醚 (PBDE)
连接器 (Connector)	X	O	O	O	O	O
O: 表示有毒有害物质在该部件所有的均质材料中的含量均在SJ/T 11363-2006规定的限量要求以下。 X: 表示该有毒有害物质至少在该部件的某一均质材料中的含量超出SJ/T 11363-2006规定的限量要求。						

Andrew Corporation  
 3 Westbrook Corporate Center, Suite 900, Westchester, Illinois U.S.A. 60154  
 +1 (708) 349-3300 Fax (U.S.A.): 1-800-349-5444  
 www.andrew.com

**Customer Service 24 hours**  
 U.S.A., Canada, Mexico: 1-800-255-1479  
 U.K.: 0800 250055  
 Other Europe: +44 592 782 612

Notice: Andrew disclaims any liability or responsibility for the results of improper or unsafe installation, inspection, maintenance, or removal practices.  
 Aviso: Andrews no acepta ninguna obligación ni responsabilidad como resultado de prácticas incorrectas o peligrosas de instalación, inspección, mantenimiento o retiro.  
 Avis: Andrew décline toute responsabilité pour les conséquences de procédures d'installation, d'inspection, d'entretien ou de retrait incorrectes ou dangereuses.  
 Hinweis: Andrew lehnt jede Haftung oder Verantwortung für Schäden ab, die aufgrund unsachgemäßer Installation, Überprüfung, Wartung oder Demontage auftreten.  
 Atenção: A Andrew abdica do direito de toda responsabilidade pelos resultados de práticas inadequadas e sem segurança de instalação, inspeção, manutenção ou remoção.  
 Avvertenza: Andrew declina eventuali responsabilità derivanti dall'esecuzione di procedure di installazione, ispezione, manutenzione e smontaggio improprie o poco sicure.  
 注意: Andrew 公司申明對於不恰當或不安全的安裝、檢驗、維修或拆卸操作所導致的後果不負任何義務和責任