

NDX-06BTMOU-A2000F



DLX® Fiber Indexing Terminal, 1x4 Splitter, 4 Forward Ports, 1 Reverse Port, Dielectric Flat Loose Tube Cable, 2000 Feet

Product Classification

Regional Availability	North America
Product Type	Access terminal, indexed with splitter
Product Brand	DLX®
Product Series	NDX

General Specifications

Cable Type	Dielectric - Flat - Loose Tube
Cable, quantity	1
Distribution Type	1 x 4 splitter
Enclosure Color	Black
Forward Port Type	Hardened mini-size (DLX) adapter
Forward Port, quantity	4
Mounting	Handhole Pedestal Pole
Port Type	Hardened multi-fiber (HMFOC) jack
Port, quantity	4
Reverse Port Type	Hardened mini-size DLX
Reverse Port, quantity	1
Splitter, quantity	1
Stub Type	Hardened multi-fiber (HMFOC) plug

Dimensions

Height	297.8 mm 11.724 in
Width	130.3 mm 5.13 in
Depth	90.4 mm 3.559 in

NDX-06BTMOU-A2000F

Cable Stub Length

609.6 m | 2000 ft

Cable Outer Diameter

4.5 x 8.1 mm (0.18 x 0.32 in)

Dimension Drawing

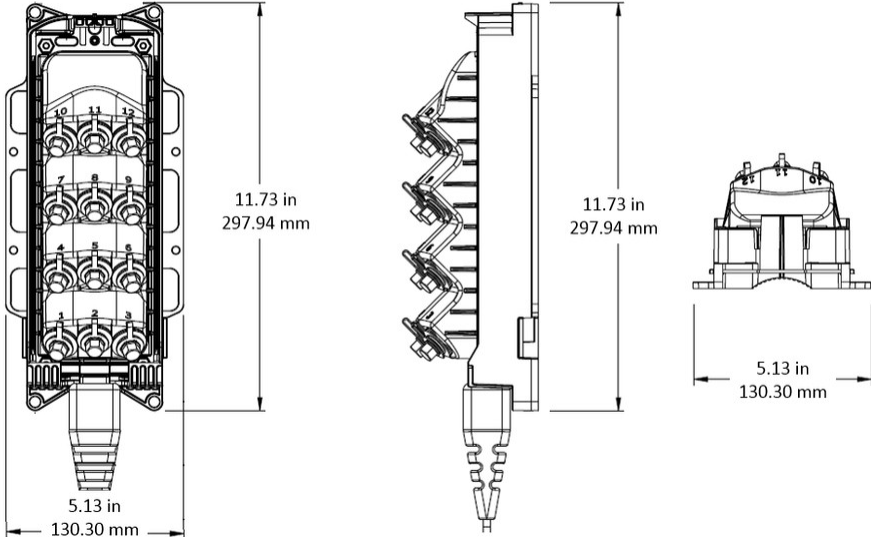

Ordering Tree

NDX-06BTMOU-A2000F

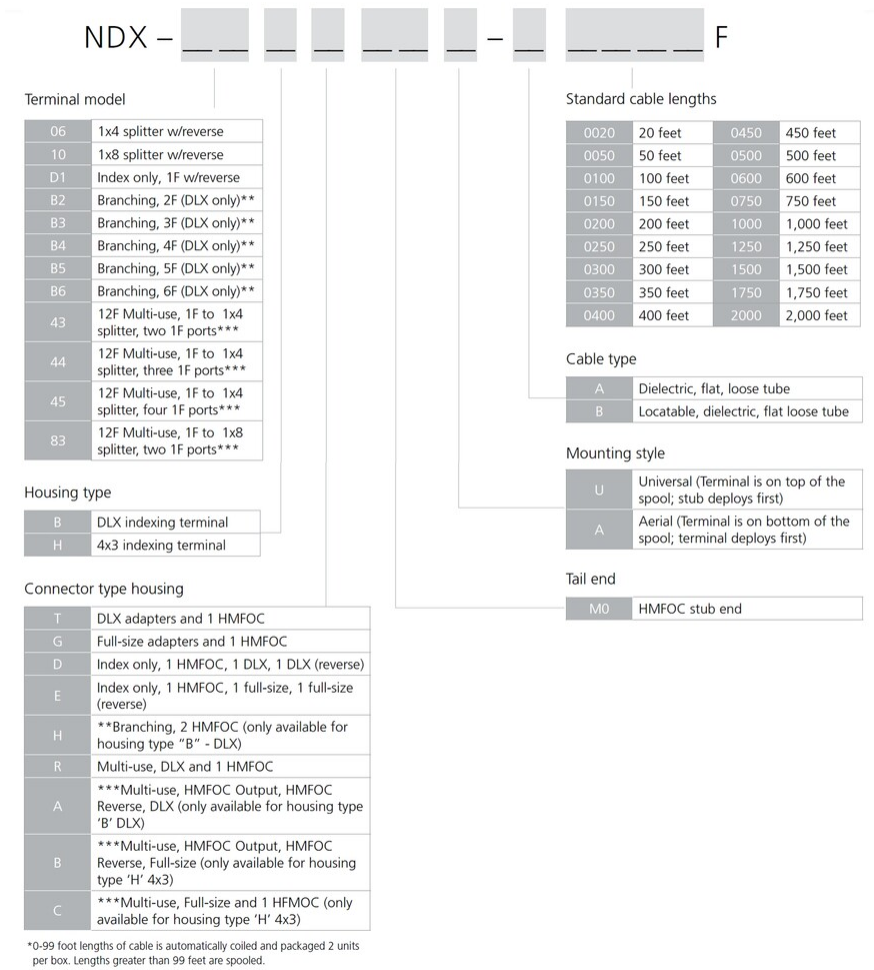

Material Specifications

Enclosure Material Type

Gasketed hardened plastic

Optical Specifications

Fiber Type

G.652.D

Operating Wavelength Range

1260 – 1635 nm

Attenuation Cable Coefficient, maximum

0.30 dB/km @ 1550 nm | 0.40 dB/km @ 1310 nm

Attenuation Splitter, maximum

7.1 dB

Attenuation Terminal Connectors, maximum

0.45 dB

Directivity, minimum

60 dB

Uniformity, maximum

0.8 dB

Insertion Loss, Splitter, typical

6.7 dB

NDX-06BTMOU-A2000F

Insertion Loss, Stub Connector, maximum	0.45 dB
Insertion Loss, Stub Connector, typical	0.16 dB
Insertion Loss, Terminal Connector, typical	0.16 dB
Return Loss, Connector, minimum	65 dB
Return Loss, Single Ports, minimum	55 dB

Environmental Specifications

Operating Temperature	-40 °C to +70 °C (-40 °F to +158 °F)
Relative Humidity	5%–100%, condensing
Environmental Space	Above ground Below ground Buried
Flammability Rating	UL 94 V-0
Qualification Standards	IEC 60529, IP68 + 2 m waterhead NEMA, Type 6 + 10 ft waterhead Telcordia GR-3120-CORE Telcordia GR-326-CORE Telcordia GR-771-CORE
UV Resistance	UV stabilized

Packaging and Weights

Included	Enclosure (1) Optical splitter (1) Universal mounting bracket (1)
Packaging quantity	1
Packaging Type	Box Carton
Weight, without cable	1 kg 2.205 lb

Regulatory Compliance/Certifications

Agency	Classification
CHINA-ROHS	Below maximum concentration value
ISO 9001:2015	Designed, manufactured and/or distributed under this quality management system
REACH-SVHC	Compliant as per SVHC revision on www.commscope.com/ProductCompliance
ROHS	Compliant



Included Products

- MST-UMB-MINI – DLX® Mini-MST, Fiber Optic Universal Mounting Bracket

MST-UMB-MINI



DLX® Mini-MST, Fiber Optic Universal Mounting Bracket

Product Classification

Regional Availability	EMEA Latin America North America
Product Type	Mounting bracket
Product Brand	DLX®
Product Series	Mini-MST

General Specifications

Color	Black
--------------	-------

Environmental Specifications

Environmental Space	Outdoor
----------------------------	---------

Packaging and Weights

Packaging quantity	1
Packaging Type	Bag Carton

Regulatory Compliance/Certifications

Agency	Classification
CHINA-ROHS	Below maximum concentration value
REACH-SVHC	Compliant as per SVHC revision on www.commscope.com/ProductCompliance
ROHS	Compliant

