



## FOSC® 450 A4 Fiber Optic Splice Closure with one 8-port tap, 15 dB

- Single-ended, O-ring sealed dome closure for splicing feeder and distribution cables
- Gel cable sealing technology allows easy adding or removing of a wide size range of cables
- Compatible with most common cable types: e.g. loose tube, central core, ribbon fiber
- FOSC splice trays hinged for access to any splice without disturbing other trays
- Closure can be used in aerial, pedestal and underground (up to 5 meters) environments
- Compatible with CommScope's CWDM modules and optical splitter trays

## Product Classification

<b>Regional Availability</b>	Latin America   North America
<b>Product Type</b>	Single-ended, round fiber closure
<b>Product Brand</b>	FOSC®
<b>Product Series</b>	FOSC 450

## General Specifications

<b>Cable Entry Drop Port Style</b>	Round
<b>Cable Entry Main Port Style</b>	Round
<b>Cable Ports Quantity, total</b>	6 round ports
<b>Cable Sealing Type</b>	Compressed gel
<b>Closure Sealing Type</b>	Dome-to-base clamp with O-ring
<b>Closure Style</b>	Single-ended
<b>Color</b>	Black
<b>Flash Test Valve</b>	None
<b>Ground Feed-through</b>	None
<b>Mounting</b>	Pole   Strand   Wall
<b>Network Area Type</b>	Drop
<b>Splice Tray Included, quantity</b>	2
<b>Splice Tray Type Included</b>	12-way, heat shrink
<b>Splicing Capacity, Mass Fusion, maximum</b>	288
<b>Splicing Capacity, Single Fusion, maximum</b>	144
<b>Splicing Capacity, Single Splice, 12 fibers, maximum</b>	144
<b>Splicing Capacity, Single Splice, 6 fibers, maximum</b>	72

# 461411-000 | FOSC450-B6-6-TAP-8P-15

**Splicing Type, Supported**

Mass fusion | Single fusion

## Dimensions

**Length**

610 mm | 24.016 in

**Diameter**

254 mm | 10 in

**Diameter, with clamp**

291 mm | 11.457 in

**Main Cable Diameter, maximum**

25 mm | 0.984 in

## Dimension Drawing

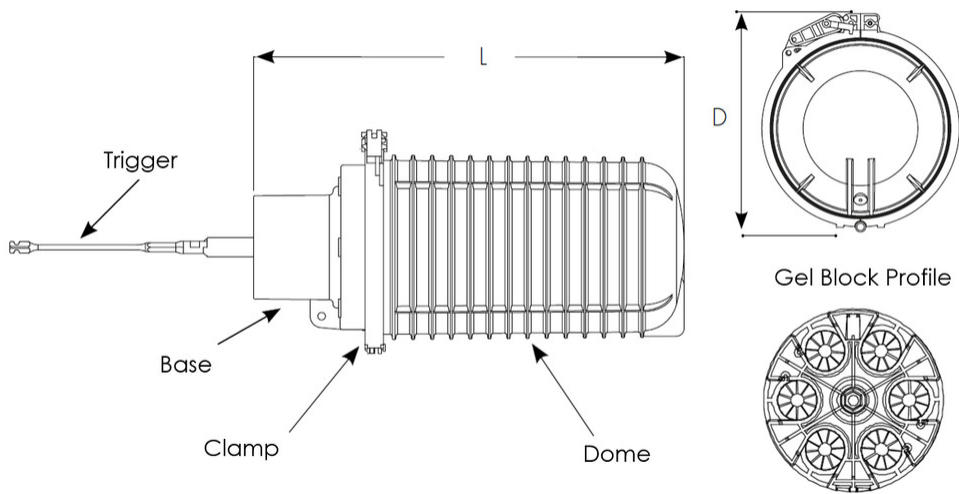

## Ordering Tree

## FOSC 450 - A4 - TAP - XX - XX

### Tap Tray Configuration

2P	2-port tap tray
4P	4-port tap tray
8P	8-port tap tray

### Tap Value and Type

04T	4 dB, terminating tap
05	5 dB, non-terminating tap
07	7 dB, non-terminating tap
07T	7 dB, terminating tap
08	8 dB, non-terminating tap
09	9 dB, non-terminating tap
10	10 dB, non-terminating tap
11	11 dB, non-terminating tap
11T	11 dB, terminating tap
12	12 dB, non-terminating tap
13	13 dB, non-terminating tap
14	14 dB, non-terminating tap
15	15 dB, non-terminating tap
17	17 dB, non-terminating tap
19	19 dB, non-terminating tap
21	21 dB, non-terminating tap

## Material Specifications

**Material Type** Impact-resistant polymer

## Environmental Specifications

**Environmental Space** Below ground | Buried

**Qualification Standards** IEC 61300, 5 m waterhead

**Water Resistance** Flash test valve at 5 psi (40 kPa)

## Packaging and Weights

**Packaging quantity** 1

**Packaging Type** Box | Carton

**Weight, net** 5.9 kg | 13.007 lb

## Regulatory Compliance/Certifications

<b>Agency</b>	<b>Classification</b>
CHINA-ROHS	Below maximum concentration value

# 461411-000 | FOSC450-B6-6-TAP-8P-15

---

ISO 9001:2015	Designed, manufactured and/or distributed under this quality management system
REACH-SVHC	Compliant as per SVHC revision on <a href="http://www.commscope.com/ProductCompliance">www.commscope.com/ProductCompliance</a>
ROHS	Compliant
UK-ROHS	Compliant

