



FACT® Fiber Optic Patch Panel, gray, 2E high, 48-port, singlemode, holding 4 hinged trays loaded with LSH/APC adapters

- Designed for use with the all-purpose all-front-access FIST-GR3 fiber frames supporting up to 2,688 LC or 1,344 SC connections in a single frame
- Reduced installation and maintenance time via the toolless snap-on design supporting both interconnect and cross-connect applications
- Flexible customization enabled by 4 chassis types (patch-only, patch-splice, pre-cabled and splice-only) to support all ODF applications
- High density through the single FACT element height (1E) being 30% less tall compared to the industry standard panel height (1HU)

Product Classification

Regional Availability	Asia Australia/New Zealand EMEA Latin America North America
Portfolio	CommScope®
Product Type	Fiber patch panel
Product Brand	FACT®
Product Series	FACT

General Specifications

Functionality	Patching
Application	Compatible with FIST-GR3-style frames
Body Style	Symmetrical
Color	Gray
Color, front	Gray
Growth Configuration	Fully loaded
Interface, front	LSH/APC
Patch Cord Routing	Left sided Right sided
Patching Capacity, maximum	48
Rack Type	EIA 19 in
Rack Units	1.4
Shelf Movement	Sliding
Total Ports, quantity	48
Transmission Standards	ETSI EN 300 019-1-3 IEC 61300-3-30

760239985 | FACT-2EPATE9

Dimensions

Height	61.9 mm 2.437 in
Width	524 mm 20.63 in
Depth	283 mm 11.142 in

Ordering Tree

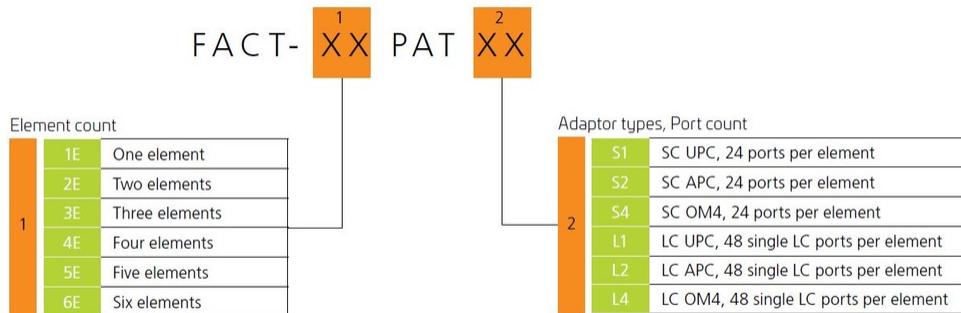

Environmental Specifications

Operating Temperature	-40 °C to +70 °C (-40 °F to +158 °F)
Storage Temperature	-20 °C to +85 °C (-4 °F to +176 °F)
Flammability Rating	UL 94 V-0

Packaging and Weights

Included	Mounting hardware
Packaging quantity	1

Regulatory Compliance/Certifications

Agency	Classification
CHINA-ROHS	Below maximum concentration value
ISO 9001:2015	Designed, manufactured and/or distributed under this quality management system
REACH-SVHC	Compliant as per SVHC revision on www.commscope.com/ProductCompliance
ROHS	Compliant

