

# RDT-XM08J00D0618A



RapidFiber® Mini-RDT, 1x8 Indexing Terminal, 3.6mm Black Riser I/O cable, female MPO at far end, 200 ft

- Designed to provide a quick and simple solution for installing fiber in small and medium sized MDU's
- Incorporates a unique fiber cable spooling system that stores up fiber cable within the enclosure
- Removes the need for field termination and extensive site survey inspections

## Product Classification

<b>Regional Availability</b>	Asia   Australia/New Zealand   EMEA   Latin America   North America
<b>Product Type</b>	Fiber distribution terminal, indexed
<b>Product Brand</b>	RapidFiber®
<b>Product Series</b>	Mini-RDT

## General Specifications

<b>Adapters, quantity</b>	8
<b>Cable Color</b>	Black
<b>Cable Entry Location</b>	Bottom left   Bottom right
<b>Cable Type</b>	Indoor/outdoor - Stranded
<b>Color</b>	Gray
<b>Distribution Type</b>	1 x 8 splitter
<b>Fibers per Feeder Cable, quantity</b>	12
<b>Front Cover Type</b>	Hinged at top
<b>Interface</b>	SC/APC
<b>Interface, stub</b>	MPO
<b>Mounting</b>	Wall
<b>Port, quantity</b>	8
<b>Splitter, quantity</b>	1

## Dimensions

<b>Height</b>	203.2 mm   8 in
<b>Width</b>	139.7 mm   5.5 in
<b>Depth</b>	60.96 mm   2.4 in

# RDT-XM08J00D0618A

**Cable Length** 60.96 m | 200 ft

**Outer Cable Diameter** 4 mm | 0.157 in

## Dimension Drawing

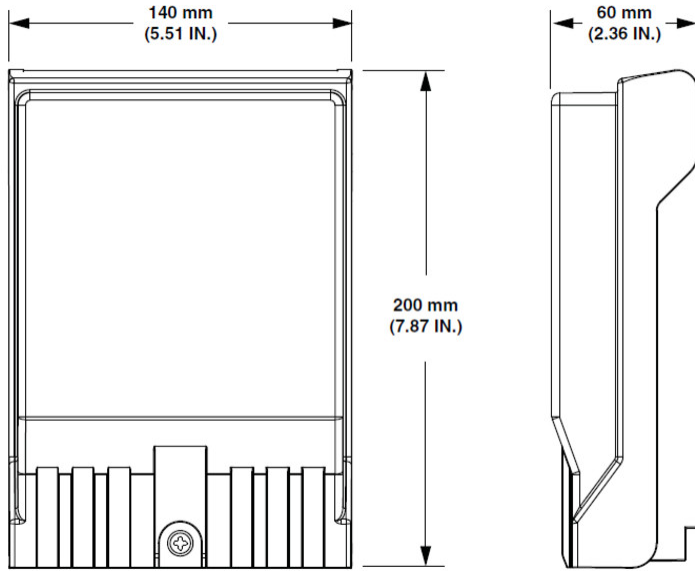

## Material Specifications

**Material Type** Plastic

## Optical Specifications

**Fiber Mode** Singlemode

## Environmental Specifications

**Environmental Space** Indoor

**Qualification Standards** Telcordia GR-1435-CORE | Telcordia GR-3123-CORE | Telcordia GR-326-CORE

## Packaging and Weights

**Packaging quantity** 1