

EQ-HR1015

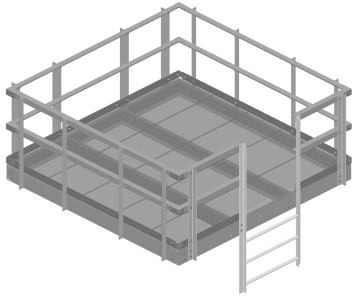

Handrail Kit for 10 ft x 15 ft equipment platform

Product Classification

Product Type Equipment platform system

Dimensions

Length 4.6 m | 15.0 ft
Width 3.0 m | 10.0 ft
Height 1219.2 mm | 48.0 in
Weight 401.9 kg | 886.0 lb

General Specifications

Includes Angle brackets | Hardware | Posts
Material Type Hot dip galvanized steel
Mounting EQ series platform bases
Package Quantity 1

Outline Drawing

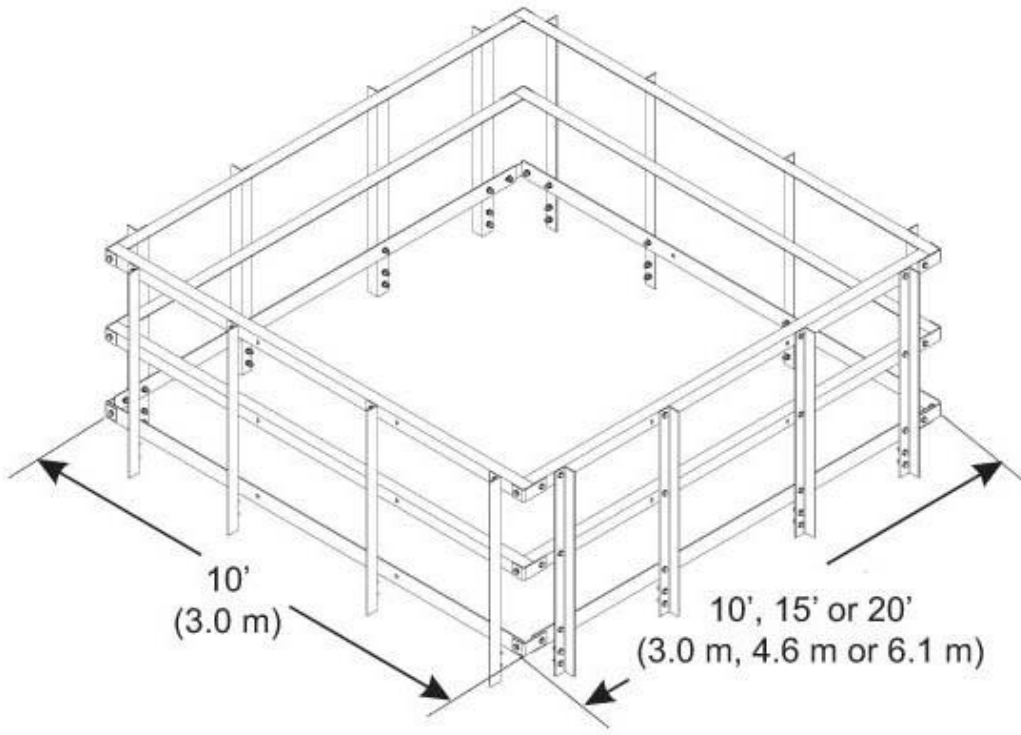

Regulatory Compliance/Certifications

Agency

ISO 9001:2015

Classification

Designed, manufactured and/or distributed under this quality management system

