

## AMPINNERGY® Power Entry Cable Assembly, 5-wire/3-circuit (3-1-1), shared neutral, 50 feet

- Used to interface between manufactured wiring and other wiring systems, such as building wiring, fixture wiring, or access floor module wiring
- Mates to line connector cable assemblies, power junction boxes, power distribution modules (PDMs), zone distribution modules (ZDBs) and power transition units (PTUs)

## Product Classification

<b>Brand</b>	AMPINNERGY®
<b>Product Series</b>	AMPINNERGY
<b>Product Type</b>	Power entry cable assembly
<b>Regional Availability</b>	North America

## Dimensions

<b>Cord Length</b>	15.24 m   50.00 ft
<b>Exposed Conductor Length</b>	12.00 in

## Electrical Specifications

<b>Current Rating, maximum</b>	20.00 A
<b>Voltage Rating, maximum</b>	125.00 Vac   250.00 Vac

## Environmental Specifications

<b>Environmental Space</b>	Indoor
<b>Safety Standard</b>	CEC 2015   CSA 22.2   NEC 2013   UL 1286   UL 183   UL 498

## General Specifications

<b>Application</b>	Line entry connection
<b>Construction Type</b>	Corrugated hose
<b>Interface, connector A</b>	Power male plug
<b>Interface, connector B</b>	Unterminated
<b>Neutral Conductor Gauge, solid</b>	10 AWG
<b>Neutral Type</b>	Shared
<b>Package Quantity</b>	1
<b>Packaging Type</b>	Bag

## Mechanical Specifications

<b>Wiring</b>	5-Wire/3 Circuit (3-1-1)
---------------	--------------------------

Outline Drawing

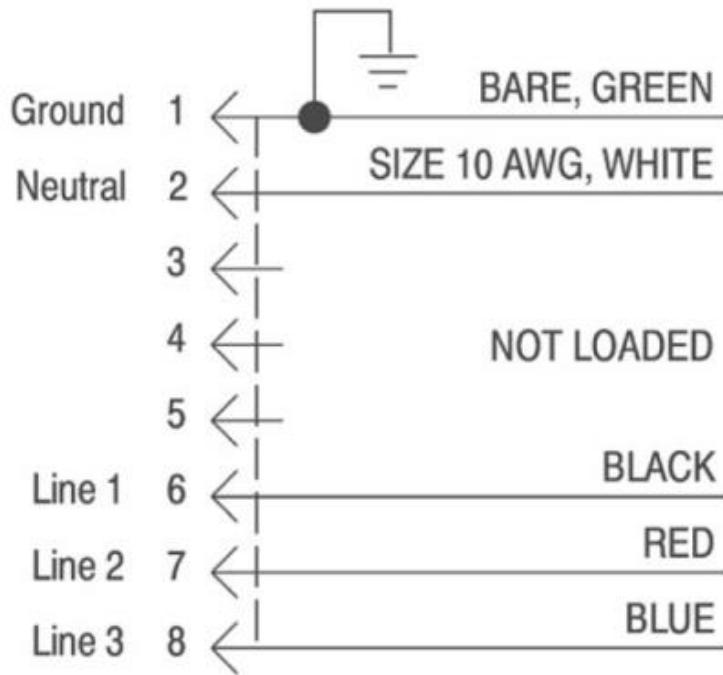

Outline Drawing

Used as an image placeholder

Regulatory Compliance/Certifications

Agency

RoHS 2011/65/EU

Classification

Compliant

