



BUDI Fiber Optic Wall mount Enclosure, empty for holding FIST Splice Trays and Fiber Optic Adapters, no lock

- Compact, wall mountable fiber enclosures for indoor and outdoor use
- Specifically designed for fast FTTH deployment and easy customer connection
- Available with splicing (FIST) and/or patching and/or splitter combinations
- Multiple and modular cable port sealing options using gel technology

Product Classification

Brand	FIST™
Product Type	Fiber wall box
Product Series	BUDI
Regional Availability	EMEA

General Specifications

Enclosure Color	Gray
Functionality	Patching Splicing
Package, quantity	1
Packaging Type	Box Carton
Splicing Capacity, maximum	48

Dimensions

Depth	120.00 mm 4.72 in
Height	340.00 mm 13.39 in
Height, with cover	420.00 mm 16.54 in
Width	240.00 mm 9.45 in

Dimension Drawing

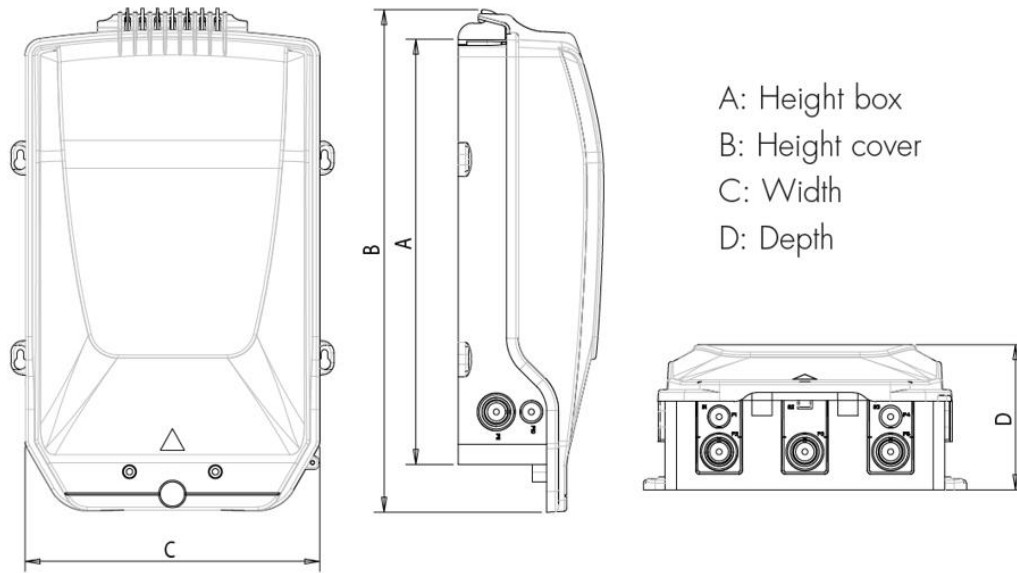

Dimension Drawing Used as an image placeholder

Mechanical Specifications

Access	Front
Enclosure Material Type	LSZH thermoplastic
Front Cover Type	Snap-on cover
Mount Type	Wall

Environmental Specifications

Environmental Space	Outdoor
Qualification Standard	IEC 60529, IP54 IEC 61753-1, category G

Regulatory Compliance/Certifications

Agency
RoHS 2011/65/EU

Classification
Compliant

